AS3037IT

Control and monitoring system for cooling towers



Instruction manual

Software version 2.01

Contents

Functional description	1
Illustration	3
Measuring values and display of functions	4
LED indicator lights.....	4
LCD display.....	4
First line.....	4
Second line.....	4
Manual operation	5
Output testing	5
Info key	6
Input modes.....	6
Output modes.....	6
Service number.....	6
Software version.....	6
Cell constant / Temperature.....	7
Cumulative water meter.....	7
Flush restrictions.....	7
Dosing output 2.....	7
Alternate dosing.....	7
Flush settings.....	7
Messages	8
Conductivity limit MIN	8
Conductivity limit MAX.....	8
Temperature MAX.....	8
Dosing tank 1 empty.....	8
Dosing tank 2 empty.....	8
Signal “Flushing blocked”.....	8
Signal “Flushing”.....	8
Signal “Supply failure”.....	9
Signal “Check clock”.....	9
Inputs	10
Water meter.....	10
Dosing tank 1 empty.....	10
Dosing tank 2 empty.....	10
Flushing blocked.....	10
Stop.....	10
Conductivity probe.....	10
Temperature.....	10

Outputs	11
Flush valve.....	11
Dosing 1.....	11
Alarm.....	11
Dosing 2.....	11
Circulation pump.....	11
Flow pulse.....	11
 Set clock	 12
 Set language	 12
 Programming	 13
1 Flushing dependency.....	14
Conductivity.....	14
2 Temperature measurement.....	16
3 Conductivity - correction factor.....	17
4 Flushing based on conductivity.....	17
5 Flushing based on volume.....	19
6 Delayed flushing.....	19
7 Programmable output functions.....	20
8 Programmable input functions.....	21
9 Alternate dosing.....	22
10 Dosing output 1.....	22
11 Dosing output 2.....	23
12 Buzzer.....	25
Alarm output.....	25
13 Code number.....	26
14 Flow pulse.....	26
 Wiring diagram AS3037IT	 27
 Technical data	 28
 Declaration of conformity	 29



Functional description

Control unit AS3037IT (wall-mounted) is designed for fully automatic monitoring and controlling of cooling tower systems.

By means of an optional plug-in card IT3037, the control options can be further extended with one temperature input and two programmable outputs.

Via plug-in card IT3037 an circulation pump can be controlled. The pump will be activated when the flush valve is opened or when the shot dosing is activated.

You can always change the basic values that have been programmed into the control system. You can define a code to protect the system against unauthorised programming.

The control has various phases, as described below.

“Service” phase

In the “Service” phase the flush valve is closed and any dosing functions can be activated.

The flush valve can be controlled on the basis of volume and / or conductivity.

“Flush” phase

In the “Flush” phase the flush valve is open. Any dosing functions are disabled.

Flushing can be stopped manually by pressing the keys and at the same time.

“Flush stop” phase

If flushing is required during a specific period of time (on the basis of conductivity) and if after the set time the conductivity is not low enough, then an alarm can be activated for the flushing. You can program whether the flushing is repeated automatically or whether manual flushing must be activated.

“Flushing blocked” phase

In the “Flushing blocked” phase the input FB is activated. The phase will be left if the input is deactivated.

“Dosing” phase

In the “Dosing” phase the dosing output is activated on the basis of a time interval, the time or a water volume interval (for instance biocide dosing).

The dosing output is activated during a programmable period of time.

For flushing on the basis of conductivity you can postpone checking the conductivity during a programmable time after the dosing has been switched off, because high concentrations of chemicals can still be present in the tank.

It is also possible to activate the flush valve before the shot dosing will be activated.

The flush limit is determined at the programmed flush limit (4.1) minus the programmed hysteresis (4.2). If one or more flush attempts (4.4) are programmed there will be flushed only once during the programmed flush time.

Dosing can be stopped manually by pressing the keys and at the same time.

“Standby” phase

If the input function “Stop” (ST) is activated the controller will be switched to the Standby position. The flush valve and dosing outputs will be switched off.

The alarms for the level switches of the dosing tanks and the input “flushing blocked” will be disabled.



Conductivity measuring

The control system is equipped with a conductivity meter. This meter measures and checks the conductivity of the water in the circulation tank.

The conductivity meter has been designed for two measuring ranges and automatically switches the measuring range. The measuring range depends on the applied measuring cell.

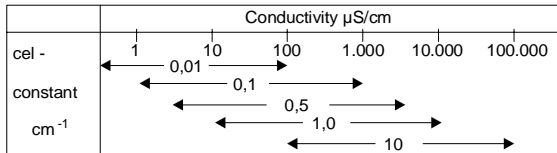

To check if the conductivity measurement is functioning correctly, you can always program a lower and an upper threshold limit value with a programmable delay.

A buzzer or an alarm relay can signal if the threshold limit value has been exceeded.

Calculation of the measuring range:

$$\begin{aligned} \text{Minimum} &= \text{cell constant} * 10 \mu\text{S} \\ \text{Maximum} &= \text{cell constant} * 10,000 \mu\text{S} \end{aligned}$$

Temperature compensation

The control can be provided with a temperature measurement.

If the temperature probe has been attached, the measured conductivity value is automatically compensated for temperature.

By entering a temperature value that deviates from the standard reference temperature of 25 °C it is possible to manually compensate the measuring value in accordance with the programmed water temperature.

See the diagram below for the correction factor that is applied for the compensation.

Temperature compensation

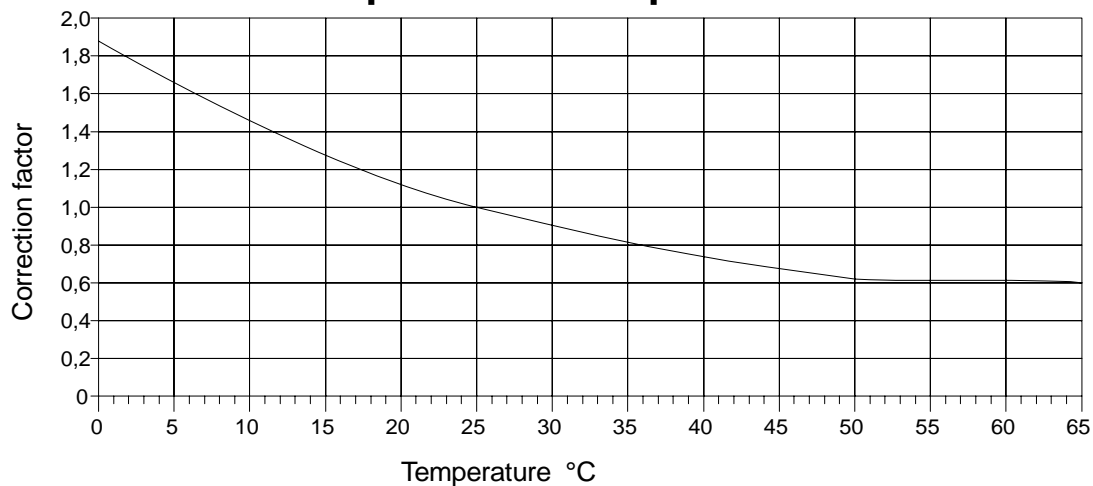

Example :

Set water temperature	T	= 11 °C
Measured conductivity value	C	= 100 $\mu\text{S/cm}$
Applied correction factor	K	= 1.4
Displayed conductivity	C	= 140 $\mu\text{S/cm}$

Illustration

Wall-mounted

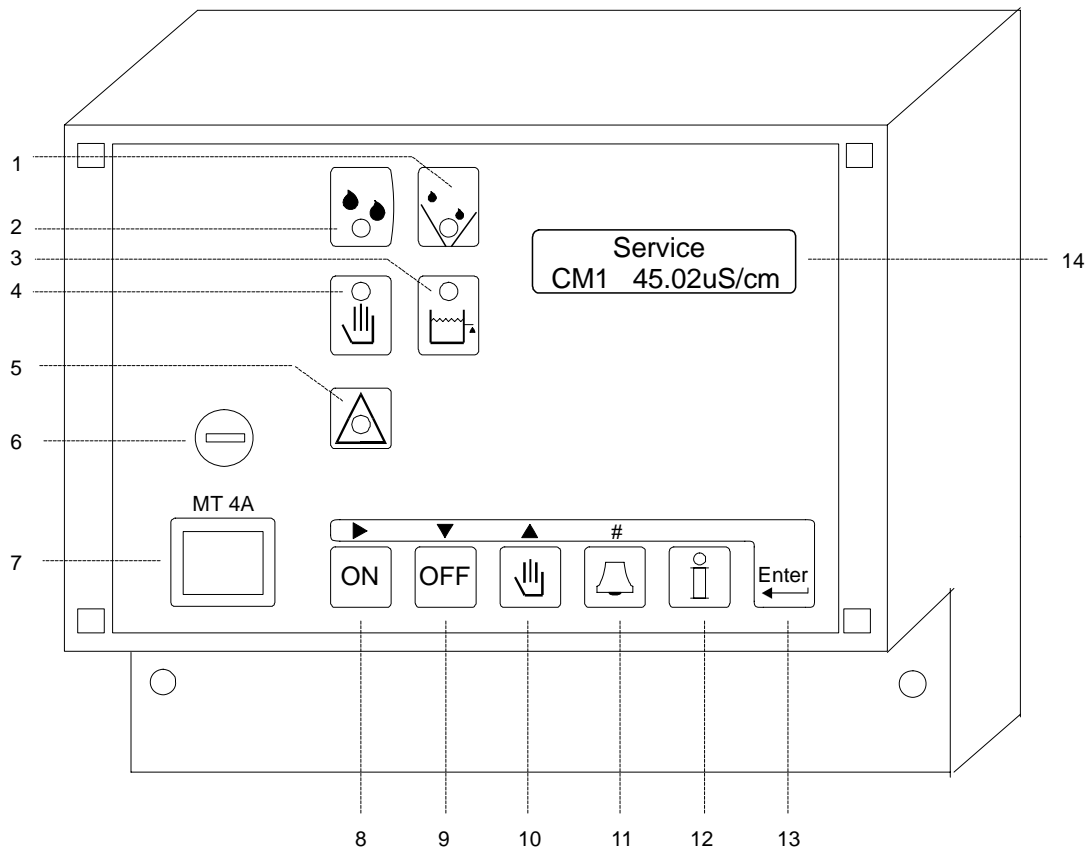

- 1 Led : Flush
- 2 Led : Water meter
- 3 Led : Dosing tank empty
- 4 Led : Manual operation
- 5 Led : Alarm

- 6 Main fuse
- 7 Main switch
- 8 Key : ON
- 9 Key : OFF
- 10 Key : Manual

- 11 Key : Reset
- 12 Key : Info
- 13 Key : Programming
- 14 LCD display



Measuring values and display of functions

LED indicator lights

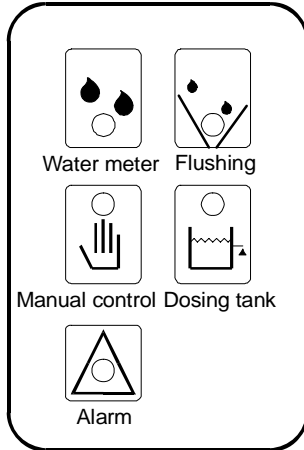

Coloured lights signal the most important conditions.

Water meter	(green)
Flush	(green)
Manual operation	(orange)
Dosing tank 1 or 2 empty	(orange)
Alarm	(red)

The LCD display provides additional information.

LCD display

First line

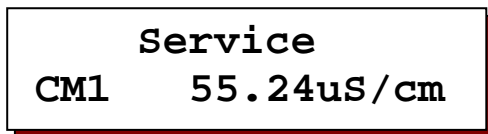

The first line of the LCD display shows the actual situation (phase) of the installation.

The following phases can be distinguished :
Service, Standby, Flushing, Flushing Stop,
Flushing blocked, Dosing.

Second line

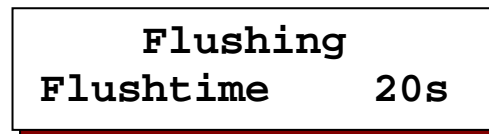

The second line of the LCD display can show the following information, either or not alternately.

Water meter	: "Water 100.00m3"
Conductivity	: "CM1 55.24 μ S/cm"
Temperature	: "Temp 24°C"
Flushing delayed	: "No Flush 00:00"

Remaining flush time	: "Flushing 20s"
Flush interval time	: "Delay 150s"
Flush before dosing	: "Flush before do."
Circulation pump on	: "Pump time 5m"



Manual operation

The outputs can be controlled manually. The manual operation can be activated by pressing key  for about three seconds.

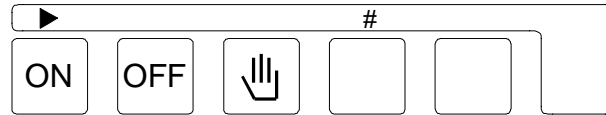

Confirmation

First you are asked whether you indeed want to activate the manual control.

```

Manual mode   30
              Y/N
  
```

Confirmation has to be entered within 30 seconds (remaining time is indicated in right hand top corner). Manual operation can be activated by placing the cursor under the "J" and pressing key .

Programming mode

If the manual control has been activated, you must first program which outputs have to be activated.

During the programming mode the manual control LED will flash.

The display shows the following text :

```

Manual prog.
FV-D1-D2-AL-PU-
  
```

If "Dosing 2" (D2) or "Alarm" (AL) have not been programmed, they will not be displayed.

If the plug-in card has been installed, "PU" will be displayed. With key  you can select the output to be programmed and by pressing key "#" you can activate or deactivate the output ("|" = active, "-" = not active).

Manual control on / off

By pressing the key  once more you can activate the manual control. At first, the control is in the "Manual control off" mode.

```

Manual off
FV-D1-D2-AL-PU-
  
```

All outputs are still switched off. You can activate the programmed outputs by pressing the "ON" key.

```

Manual on
FV-D1-D2-AL-PU-
  
```

You can deactivate the outputs again by pressing the "OFF" key. Press the  key to return to the programming mode.

Closing

You can close the manual control mode by pressing the  key for about three seconds.



INFO - displays

With the Info key you can call up various types of information and values. In as far as possible, changes are described in the "Programming" chapter.

By calling up the Info key you can only change the service phone number.

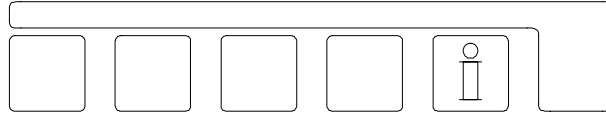

Press the Info key with the  symbol. The first set of information appears. If you then press the key again, the next set of information appears, etc.

Input modes

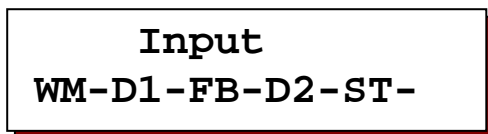

The current switch modes of the inputs are displayed.

If an IT3037 plug-in card has been installed, the fifth position is shown as well.

WM = Water meter
D1 = Dosing tank 1 empty
FB = Flushing blocked
D2 = Dosing tank 2 empty
ST = Stop

A horizontal line ' - ' next to the indication means : input not active.

A vertical line ' | ' next to the indication means : input active.

Output modes

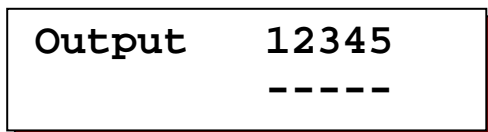

The current switch modes of the outputs are shown.

Each figure is allocated to a relay.

The fourth and fifth position are shown if an IT3037 plug-in card has been installed.

A horizontal line ' - ' underneath a figure means : output not active.

A vertical line ' | ' underneath a figure means : output active.

Service number

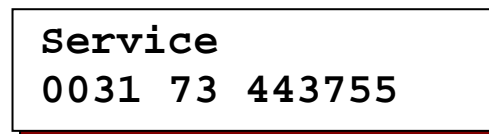

A service phone number is displayed. You can also change the number here.

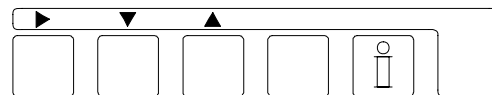

Change the phone number :

Select number : ►

Lower number : ▼

Higher number : ▲

Software version

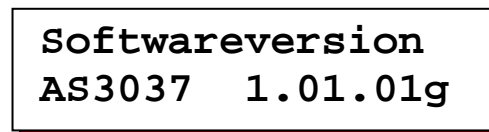

The software version is continuously updated in the factory. The software is changed to adapt the product to new insights and requirements.

Displayed is the number of the presently installed version.

Cell constant and temperature

Celconst. /Temp.
C1=0.10/cm 25°C

The display shows the cell constant entered in program step 1.2 and the water temperature entered in program step 2.1. If the a plug-in expansion card IT3037 has been installed and the temperature probe has been connected, the measured temperature will be displayed.

Cumulative water meter

Watermeasurement
0.50m3

The display shows the total supplied volume of water.

Flush restrictions

Blocktime
00:00 - 06:30

If in program step 6 a blocked time has been entered during which no flushing is allowed, then this blocked time is displayed. In the other case 'Nee' (No) is displayed.

Dosing output 2

If in step 7 the output function 'D2' has been programmed, then the parameters of dosing function 2 are displayed. In the other case 'Nee' (No) is displayed.

Dosing output 2
Factor = x1

Dosing dependent on the water meter: the dosing factor is displayed.

Dosing output 2
Time

Dosing dependent on the clock.

Dosing output 2
1440m 1440m 15m

Dosing dependent on a time interval.

Subsequently, the following information is displayed: set interval time, remaining time until the following dosing and dosing time.

Dosing output 2
10m3 5.0m3 15m

Dosing dependent on a water volume interval. Subsequently, the following information is displayed: programmed interval volume, remaining volume until the following dosing and dosing time.

Alternate dosing

Altern.dosing
30d 26d DO1

This information is displayed if the alternate dosing has been set in step 9. Subsequently, the following information is displayed :

30d = set interval time
26d = remaining time until the dosing output changes
DO1 = currently active dosing output

Flush settings, volume

Flushing WM
100.00m3 23s

If in step 1 flushing based on volume has been set, then here subsequently the flush limit and the programmed flush time are displayed.

Flush settings, conductivity

Flushing CM
100.00/0.0/23s

If in step 1 flushing on the basis of conductivity has been set, then here subsequently the flush limit, the hysteresis and the programmed flush time are displayed.

If '*' is displayed for the flush time, then no flush time has been programmed and flushing is halted if the measured conductivity is below the flush limit minus the hysteresis.



Messages

For certain situations a message can be programmed to appear on the LCD display and an alarm relay and/or buzzer can be activated.

If an alarm relay and/or buzzer has been programmed, these can be switched off by pressing the  key.

Once the cause of the message has been cleared, the message on the LCD display can be cleared by once again pressing the  key.

Conductivity limit MIN

**Limit CM1 Min
under valued**

The conductivity has been below the minimum threshold limit value for longer than the set delay.

Possible causes :

Air at the measuring probe, electric interruption of the measuring probe.

Conductivity limit MAX

**Limit CM1 Max
exceeded**

The conductivity has been above the maximum threshold limit value for longer than the set delay.

Possible causes :

Set value of the installation has been changed, measuring probe short-circuited, thickening too high.

Temperature MAX

**Limit Temp. Max
exceeded**

In step 2.3 you can select whether a maximum temperature value must be monitored.

Dosing tank 1 empty

**Dosing tank 1
Empty**

The chemicals tank for dosing 1 is empty.

In step 8.5 you can set whether the dosing output must be blocked as long as the input is still active.

Dosing tank 2 empty

**Dosing tank 2
Empty**

The chemicals tank for dosing 2 is empty.

This message can only appear if the second dosing output has been selected.

In step 8.6 you can set whether the dosing output must be blocked as long as the input is still active.

Signal "Flushing blocked"

**Signal
Flushing blocked**

Flushing will be blocked until the input is deactivated again.

Signal "Flushing"

**Signal
Flushing**

This message appears if after the set flush time the conductivity still lies above the set flush limit.

This message does not appear if flushing only takes place on the basis of volume or if no flush time has been programmed.

**Signal “Supply failure”**

**Signal
Supply fail.**

The supply voltage for the control failed or was switched off.

ATTENTION ! In case of a power failure all programmed values are saved.

Signal “Stop”

**Signal
Stop**

This message will be shown in the display when the input “Stop” is activated and programmed for an alarm in step 12.

Signal “Check clock“

**Signal
Check clock**

The supply voltage for the control failed or was switched off.



Inputs

The inputs "Water meter", "Dosing tank 1 empty" are standard available.

The input functions "Flushing blocked", "Dosing tank 2 empty", "Stop" and "Level switch" are programmable on the terminals LL and DT2.

In program step 8 you can set whether the functions must be activated for an open or a closed contact.

Water meter

The connector for the water meter is indicated by "WM".

Impulse water meters give off an impulse after each flow, for instance of 100 litres. These impulses are counted by the control system and on reaching the set flush volume a flush is activated.

The impulses can also be used for controlling dosing output 1 and dosing output 2.

Dosing tank 1 empty

The connector for "Dosing tank 1 empty" is indicated by "DT1".

By means of this input the stock of chemicals in dosing tank 1 can be monitored.

Dosing tank 1 is linked to dosing output 1 and in step 8.5 you can set whether the output must be blocked if the dosing tank is empty.

Dosing tank 2 empty

By means of this input the stock of chemicals in dosing tank 2 can be monitored.

Dosing tank 2 is linked to dosing output 2 and in step 8.6 you can set whether the output must be blocked if the dosing tank is empty.

The input is not checked if dosing output 2 has not been selected in step 7. If in step 11 a surge dosing has been programmed (11.0 on "TM", "CL", "VO") then the dosing is interrupted until once again sufficient chemicals are present.

Flushing blocked

Flushing can be blocked through an external contact.

For example :
The circulation tank can be secured against draining by blocking the flush during an active input signal.

Stop

The installation is switched off (Standby) and the dosing outputs and the flush valve are switched off.

Conductivity probe

The connector for the counter is indicated by "CC".

Don't forget to enter the correct cell constant in program step 1.2.

Temperature

For the temperature gauge a PT1000 must be used.

The connector is indicated by "TC". This probe can be built into the measuring cell or installed as a separate temperature probe next to the measuring cell.

If no temperature probe is connected, calculations are automatically based on the temperature set in program step 4.1. The same applies in case of short-circuiting or interruption.



Outputs

The outputs "Flush valve" and "Dosing 1" are standard available.

The output "OUT1" can be programmed for the functions "Alarm" (Alarm) or "Dosing 2".

Optionally, (plug-in card IT3037) the control system can be provided with an circulation pump.

In program step 7.4 you can set whether or not the functions are activated when powered.

Flush valve

The flush valve is connected to the "FV" connector.

The flush valve is controlled depending on the setting in step 1.1 on the basis of volume and / or conductivity.

The plug-in card has an option to connect a motor valve.

Dosing 1

"Dosing 1" is connected to the "DO1" connector.

The dosing is dependent on the incoming water meter impulses.

In step 10 you can set the length of every impulse, as well as the dosing factor.

By means of the dosing factor you can set the number of outgoing dosing impulses.

Example :

dosing factor = x2 :

every incoming impulse
creates 2 outgoing impulses.

dosing factor = :2 :

after 2 incoming impulses
1 outgoing impulse is created.

Alarm

With the potential-free contact of the relay, supervision consoles or signalling devices can be activated.

The events that must cause a relay action are programmable in steps 12.1 and 12.2.

The output function is programmable on output OUT1 and, if the plug-in card has been installed, also on output OUT2

Dosing 2

The output function "Dosing 2" can be programmed as a dosing dependent on the incoming water meter impulses (see also Dosing 1) or as a surge dosing (for instance biocide).

For surge dosing you can set whether this should take place on the basis of a time interval (in hours), on the basis of the clock (fixed time) or on the basis of a water volume (in 0,01 m3).

If dosing must take place on the basis of the clock then three times with related days can be programmed when the dosing must be activated.

The surge dosing is activated during a programmable time (in minutes). It is possible to interrupt the surge dosing by simultaneously pressing the OFF and Reset keys.

If the flush function is dependent on the conductivity, then also the impact time of the chemicals can be entered. The installation will not start flushing on the basis of the measured conductivity as long as the impact time is still running.

It is possible to flush before the shot dosing will be activated.

The output function is programmable on output OUT1 and, if the plug-in card has been installed, also on output OUT2

Circulation pump

Optionally, (plug-in card IT3037) a circulation pump can be controlled. The pump will be activated when the flush valve is opened or when the shot dosing is activated.

After shot dosing, the pump can be activated for a programmable time.

Flow pulse

The incoming water meter pulses are going to the output for flow pulse.



Set clock

Press the "OFF" key. The bottom line now displays the present time.



If you want to change the displayed time, place the cursor underneath the day or number that you want to change by means of key ►



With key "#" you can increase the day or the number.

You can leave the clock setting by pressing the "OFF" key again. If you do not press any key for approx. 10 seconds, the settings menu is closed automatically.

Set language

Keep the "Enter" key depressed for 5 seconds. The display now reads :

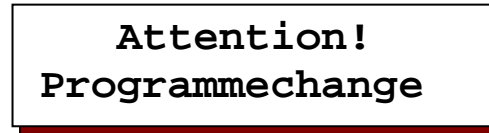

and after 5 seconds :



After these 5 seconds also press the "#" key to activate the language setting.

Then release both keys.

The display reads :

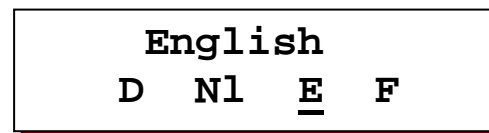

You can change the language with the ► key.

You can leave the language setting by pressing the "Enter" key again. If you do not press any key for approx. 2 minutes, the settings menu is closed automatically.



Programming

General

By entering the basic values when the system is put into operation, the control system is set to the operational data of the installation. These values can be changed and are not deleted in case of a power failure.

- The basic values should only be changed by an authorised expert.
- Note the basic values in the empty fields of the following flow charts and carefully keep this manual for use by the operational and maintenance staff.
- The basic values can be changed at all times. Some of the changed values only become active after the programming mode has been left.
- For the programming mode, the following symbols ▶, ▼, ▲ and # are used.

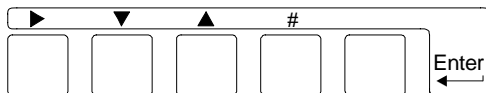

Activate

Keep the "Enter" key depressed for about 5 seconds.

The LCD display first shows :

Attention!
Programmechange

and after about 5 seconds :

Start
Programmechange

Then press the ▼ key to activate the programming.
ATTENTION! The "Enter" key must be kept depressed.

If a code has been entered in step 13, you must enter a code number with keys ▶ and # before you can call up the programming function.

Codenummer
0000

After the programming function has been activated you can release the Enter key and walk through the program steps by means of keys ▼ and ▲ .

You can leave the programming function by pressing the "Enter" key again. If you do not press any key for approx. 2 minutes, the settings menu is closed automatically.

Change settings

Yes/No setting

Change the setting by means of the ▶ key.

Set numeric value

Select the figure that needs to be changed by means of the ▶ key.
Change the value with the # key.

Set factor

Change the value with the # key.

Select from more than one function

Select the function by means of the ▶ key.

Switch functions on / off

Select the function by means of the ▶ key.
With the # key, toggle the value between " | " and " – ".

1. Flushing dependency / conductivity meter

Step no.: 1.1
WM **CM** **WM+**

Select on the basis of which parameter flushing has to take place.

WM = water meter (volume)
 CM = conductivity
 WM+ = water meter and conductivity

Step no.: 1.2
Constant 0.10

In accordance with the conductivity of the water that has to be measured, a probe with an adapted cell constant has to be selected. You can program a cell constant between 0.01 cm-1 and 10.00 cm-1 for the conductivity meter.

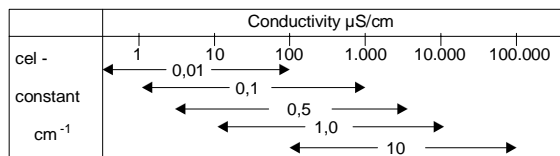

Step no.: 1.3
Limit Min Y/N

The conductivity value can be checked for a minimum value.

Step no.: 1.4
Value Min 1.00

An electrical interruption to the conductivity probe, electrical failures in the system or air at the probe can lead to the fact that incorrectly a much too low conductivity is displayed. For control purposes a threshold limit value between 0.1 – 999.9 µS/cm can be entered.

Step no.: 1.5
Delay 60s

After a programmable delay time of 5 – 999 seconds and if the conductivity value is below the set minimum value, the LCD display shows the message "Limit CM1 Min under value". In program step 12 you can set whether in addition the buzzer or an alarm relay must be activated.

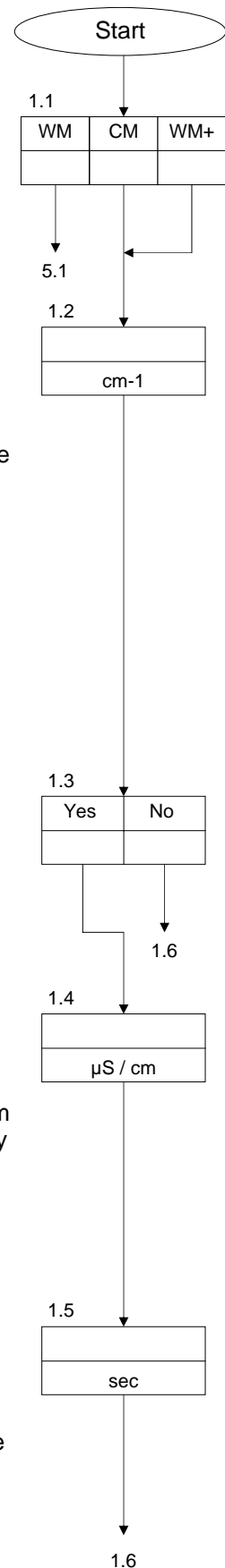



Step no.:	1.6
Limit Max	<u>Y</u>/N

The conductivity value can be checked for a maximum value.

Step no.:	1.7
Value Max	1650.<u>0</u>

For control purposes a threshold limit value of 0.1 – 999.9 $\mu\text{S}/\text{cm}$ can be entered.

Step no.:	1.8
Delay	180<u>s</u>

After a programmable delay time of 5 – 999 second and if the conductivity value is above the set maximum value, the LCD display shows the message “Limit CM1 Max. exceeded”.

In program step 12 you can set whether in addition the buzzer or an alarm relay must be activated.

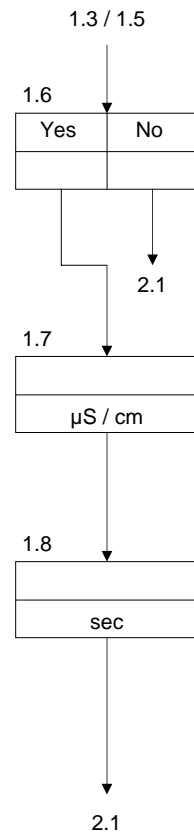

2. Temperature measurement

Step no.: 2.1
Temperature 25°C

When the expansion card IT3037 is not installed, temperatures are not measured. However, for the manual temperature compensation of the conductivity value a temperature deviating from 25°C can be entered from the range between 1 and 99°C.

If the plug-in card has been installed, but no temperature probe has been connected, this step is displayed as well.

Step no.: 2.2
Display Y/N

If an extended plug-in card is used, you can set whether the actual temperature value is displayed on the LCD display.

Step no.: 2.3
Limit Temp. Y/N

Here you can set the monitoring of the maximum water temperature.

Step no.: 2.4
Value Max 80°C

For monitoring purposes you can here enter a threshold limit value between 1°C and 99°C..

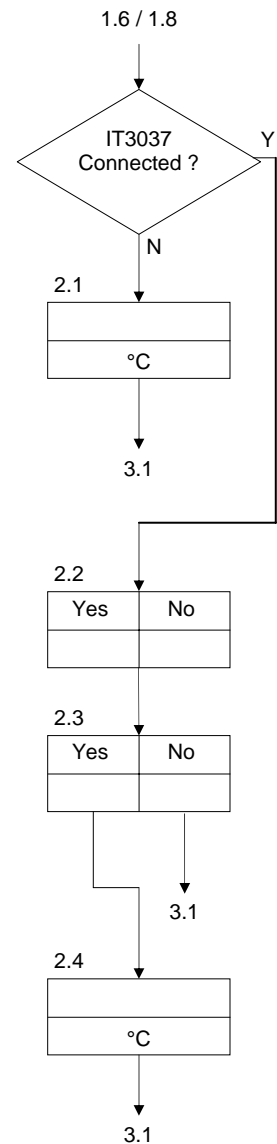

Temperature compensation

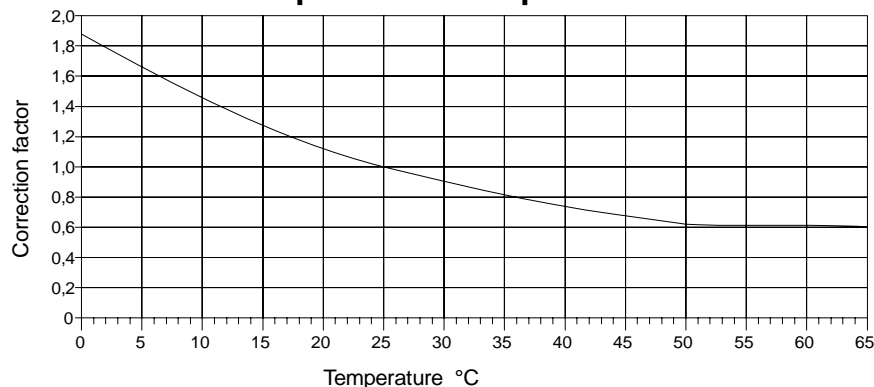

3. Conductivity – correction factor

Step no.:	3.1
Factor	1.00*

The conductivity measurement relates to a water temperature of 25°C. For deviating temperatures the displayed value can be compensated manually. Other measuring errors, for instance as a result of polarisation, line impedance or cable capacities, can be compensated, at least for a certain range, by entering a correction factor.

You can enter a correction factor of 0.1 – 5.00. How to determine the conductivity – correction factor :

Take a water sample and measure the **setting value** of the conductivity by means of an accurate measuring device.

As the **actual value** note the value that is displayed on the control system. Then calculate the **correction factor** to be entered as follows :

$$\frac{\text{Setting value}}{\text{Actual value}} = \text{Correction factor}$$

4. Flushing based on conductivity

Step no.:	4.1
Flush	1500.0

Enter the flush limit, between 1.0 – 65,000.0 µS/cm, for flushing on the basis of conductivity. If the conductivity rises above this value, then the flush valve will be opened.

Step no.:	4.2
Hysteresis	0.0

By means of the hysteresis you can set how far the conductivity, after flushing, has to fall below the flush limit before flushing is ended.

Step no.:	4.3
Delay	10s

After a programmable delay time of 1 – 999 seconds, at a conductivity value above the set flush limit, the flush valve will be opened.

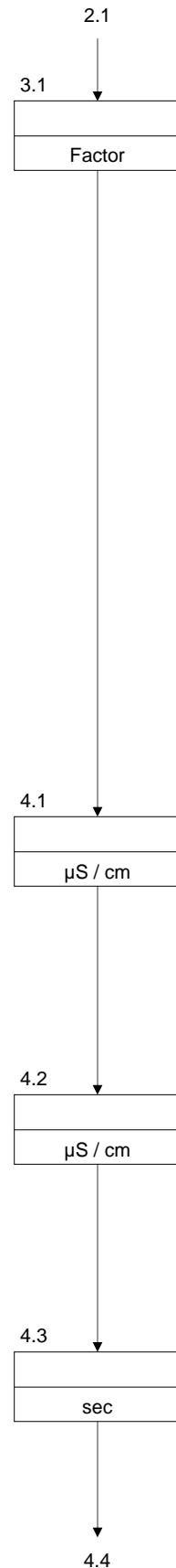

Step no.:	4.4
Switch on	<u>1</u>

Enter the number of flush attempts (0 – 9).

The control can be programmed thus that flushing takes place during a set time (attempts : 1-9) or that flushing continues until the conductivity lies below the flush limit minus the hysteresis (attempts : 0).

Step no.:	4.5
Delay	<u>1</u>m

If flushing has to take place during a certain period of time, then you can enter that the flushing should be automatically repeated after as set interval time, if after flushing the conductivity is still above the flush limit minus the hysteresis. In program step 4.5 enter the interval time of 1 – 99 minutes.

Step no.:	4.6
Flush off	<u>Y</u>/N

Here you enter whether after the number of flush attempts the installation must be stopped, so that flushing stops and automatic flushing has to be restarted manually by pressing the ON key.

Step no.:	4.7
Flushtime	<u>60</u>s

Here you enter the flush time of 1 – 9999 seconds.

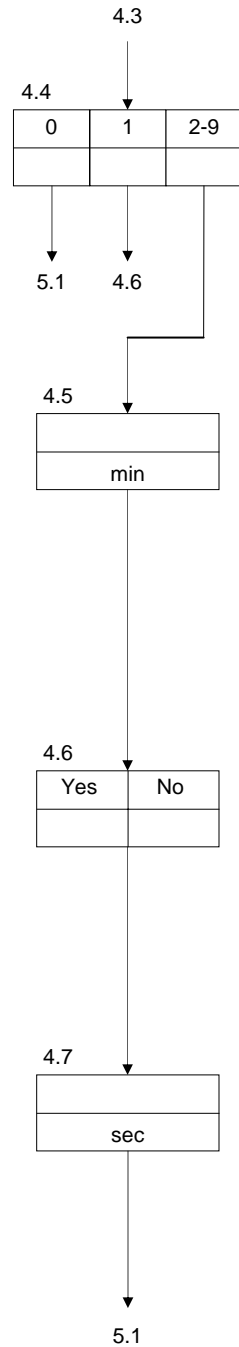

5 Flushing based on volume

Step no.:	5.1
Liter/puls	100.0

For the impulse distance of the water meter you can enter values of 0.1 – 1000.0 litres per impulse.

Step no.:	5.2
Flush	100.00m3

Here you enter the flush limit, from 0.1 – 1000.00 m3, for flushing on the basis of the supplied water. If the volume of supplied water reaches this value, then the flush valve will be opened during a set flush time.

Step no.:	5.3
Flushtime	60s

Here you enter the flush time of 1 – 9999 seconds.

6. Delayed flushing

Step no.:	6.1
Blocktime	Y/N

Flushing can be started at any moment of the day. However, it may be that this is not desirable at certain moments. Determine here if it has to be checked whether the flushing must be postponed at certain moments.

Step no.:	6.2
Starttime	00:00

Enter the start time for the period during which flushing is not allowed.

Step no.:	6.3
Stoptime	00:00

Enter the stop time for the period during which flushing is not allowed.

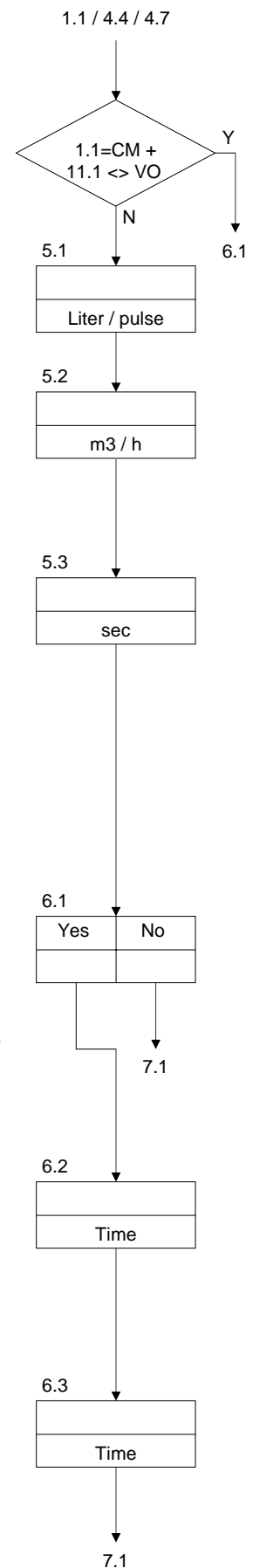

7. Programmable output functions

Step no.: 7.1

D2 AL

Select the desired output function for output OUT1.

D2 = dosing output 2
AL = alarm output

Step no.: 7.2

FV D2 AL FL

Select the desired output function for output OUT2.

FV = flush valve
D2 = dosing output 2
AL = alarm output
FL = Flow pulse

This step is only shown if plug-in card IT3037 has been installed.

Step no.: 7.3

FV D2 FL PU

Select the desired output function for output OUT3.

FV = flush valve
D2 = dosing output 2
FL = Flow pulse
PU = circulation pump

This step is only shown if plug-in card IT3037 has been installed.

Step no.: 7.4

FV-D1-D2-AL-PU-

Select the activation of the output functions for the outputs.

“ - “ Activate function when electrically powered.
“ | “ Activate function when not electrically powered.

FV = flush valve
D1 = dosing output 1
D2 = dosing output 2
AL = alarm output
PU = circulation pump
FL = Flow pulse

The output functions “D2” and “AL” are only displayed if they have been programmed in steps 7.1 or 7.2.

The output function “PU” is only displayed if plug-in card IT3037 has been installed and if this function has been selected in step 7.3.

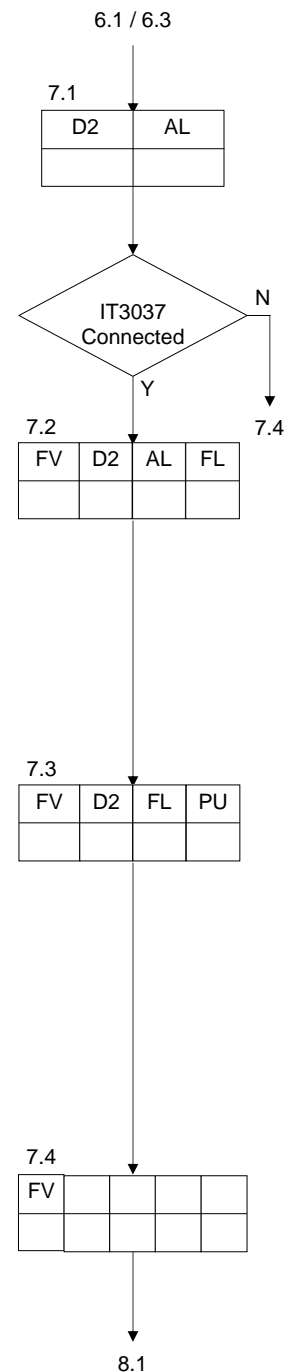

8. Programmable input functions

Step no.: 8.1

FB D2 ST

Select the input function for connection terminal LL.

FB = flushing blocked
D2 = dosing tank 2 empty
ST = stop

Step no.: 8.2

FB D2 ST

Select the input function for connection terminal DT2.

FB = flushing blocked
D2 = dosing tank 2 empty
ST = stop

Step no.: 8.4

D1- FB- D2- FU-

Select the activation of the input functions for the inputs.

"|" Activate function for closed contact (NO contact).
"- " Activate function for open contact (NC contact).

D1 = dosing tank 1 empty
FB = Flushing blocked
D2 = dosing tank 2 empty
ST = stop

The input functions "D2", "FB", "ST" are only displayed if in program step 8.1 or 8.2 are programmed for this input functions.

Step no.: 8.5

Dos.pump1 offY/N

Determine whether "Dosing output 1" must be switched off if "Dosing tank 1" is empty.

Step no.: 8.6

Dos.pump2 offY/N

Determine whether "Dosing output 2" must be switched off if "Dosing tank 2" is empty.

This window is only displayed if in program step 7 the output function "D2" has been selected.

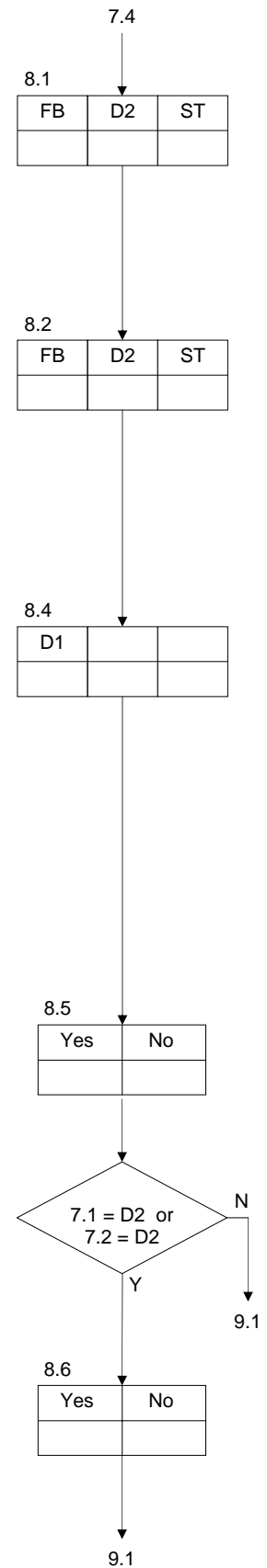

9. Alternate dosing

Step no.: 9.1
Altern.D1/D2 Y/N

Determine whether dosing outputs 1 and 2 must be alternated after a programmable interval time. One output will then react to the parameters set in step 11, whilst the other output will not react.

With the  key you can call up which output is currently active.

Step no.: 9.2
Days 30

Enter an interval time of 1 – 99 days.
 After this interval time the dosing outputs will be alternated.

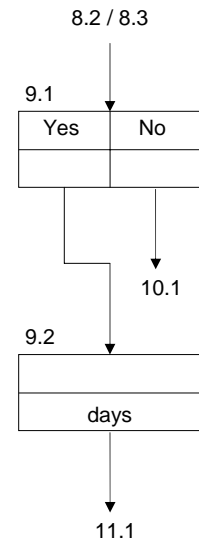
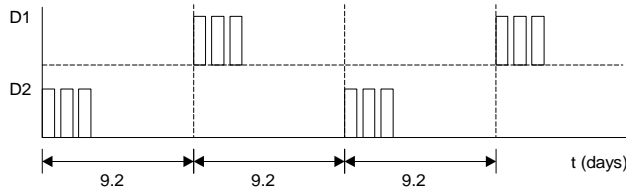

10. Dosing output 1

Step no.: 10.1
Dos.factor1 x1

Enter a dosing factor between “:10” – “x10”.
 By means of this dosing factor the number of incoming water meter impulses can be converted into more or less outgoing dosing impulses.

Example :
 Dosing factor = x3 : Every incoming impulse creates three outgoing dosing impulses
 Dosing factor = :2 : After two incoming impulses one outgoing dosing impulse is created.

Step no.: 10.2
Time low 0.5s

Enter a time between 0.2 – 999.9 seconds when the output is not short-circuited.

Step no.: 10.3
Time high 1.0s

Enter a time between 0.2 – 999.9 seconds when the output is short-circuited.

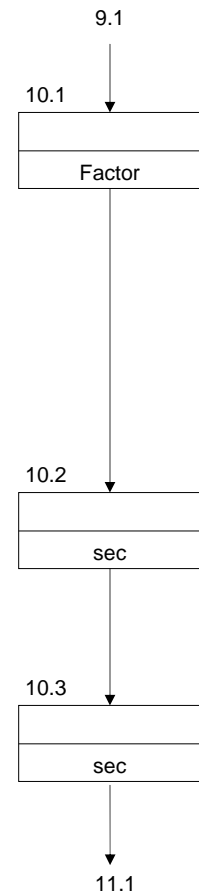
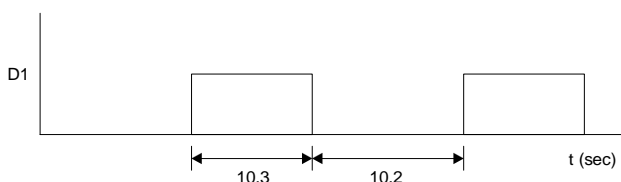

11. Dosing output 2 (Shot dosing)

Step no.:	11.0
WM	TM
CL	VO

Select the desired dosing function for dosing output 2 ("D2").

- WM = water meter incoming impulse -> outgoing impulse
- TM = time interval (shot dosing)
- CL = clock (shot dosing)
- VO = volume (shot dosing)

Step no.:	11.1
Flush b.dos.	Y/N

Determine if the flush valve has to be opened depending on the measured conductivity before the shot dosing will be activated.
 The flush limit is determined at the programmed flush limit (4.1) minus the programmed hysteresis (4.2). If one or more flush attempts (4.4) are programmed there will be flushed only once during the programmed flush time.

Water meter

Step no.:	11.2
Dos.factor2	x<u>1</u>

Enter a dosing factor between ":10" – "x10".
 By means of this dosing factor the number of incoming water meter impulses can be converted into more or less outgoing dosing impulses.

Example :
 Dosing factor = x3 : Every incoming impulse creates three outgoing dosing impulses
 Dosing factor = :2 : After two incoming impulses one outgoing dosing impulse is created.

Step no.:	11.3
Time low	0.<u>5</u>s

Enter a time between 0.2 – 999.9 seconds when the output is not short-circuited.

Step no.:	11.4
Time high	1.<u>0</u>s

Enter a time between 0.2 – 999.9 seconds when the output is short-circuited.

Time interval

Step no.:	11.5
Interval	144<u>0</u>m

Enter an time interval between 1 – 65.000 minutes, after which a surge dosing is activated during a time programmable in step 11.12.

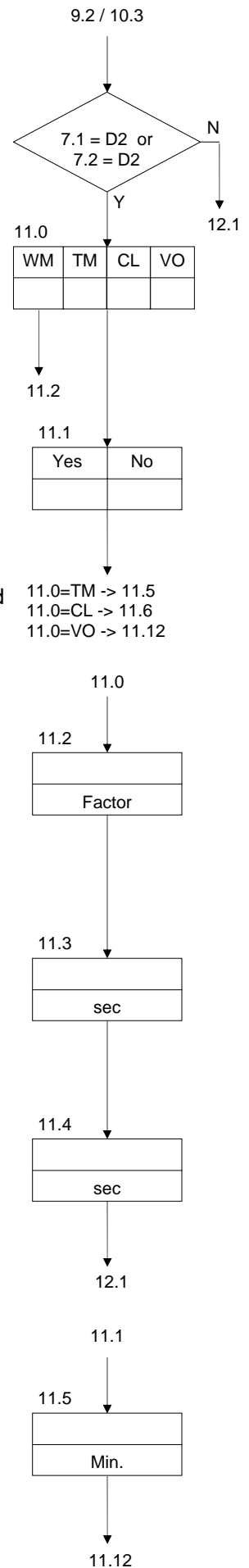

Clock

Step no.: 11.6
 Starttime1 00:00

Enter time 1 when a surge dosing must be started.

MoTuWeThFrSaSu
 _ - - - - -

Select the day(s) to which start time 1 applies.

Step no.: 11.8
 Starttime2 00:00

Enter time 2 when a surge dosing must be started.

MoTuWeThFrSaSu
 _ - - - - -

Select the day(s) to which start time 2 applies.

Step no.: 11.10
 Starttime3 00:00

Enter time 3 when a surge dosing must be started.

MoTuWeThFrSaSu
 _ - - - - -

Select the day(s) to which start time 3 applies

Step no.: 11.12
 Dosingtime 15m

Enter the dosing time for the surge dosing, between 1-999 minutes.

Step no.: 11.13
 Waittime 0m

If flushing takes place on the basis of conductivity, you can enter a period of time here, between 0 – 999

minutes, during which flushing is blocked, immediately after the surge dosing has been deactivated.
 This in connection with the impact time of the added chemicals.

Volume

Step no.: 11.14
 Distanc 10.00m3

Enter an volume interval between 0,01 – 9999,99 m3, after which a surge dosing is activated during a

time programmable in step 11.12.

Step no.: 11.15
 Pump time 5m

If a circulation pump is connected, enter the time the circulation pump should run after the shot dosing has finished (0 – 999 m).

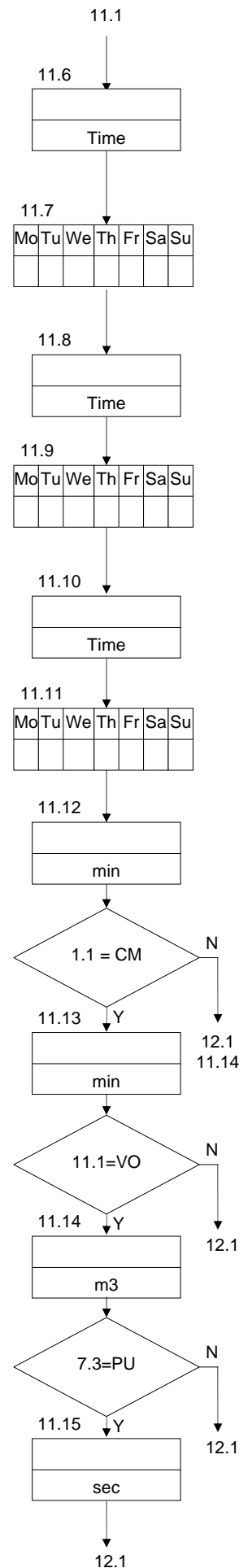

12. Alarms

Buzzer

Only those options can be programmed for which a threshold limit value has been entered in the previous program steps or for which the related input function has been selected.

Step no.: 12.1
MI-MA-D1-FB-PF-

Select the events for which the buzzer must be activated.

MI = minimum conductivity
MA = maximum conductivity
D1 = dosing tank 1 empty
FB = flushing blocked
PF = power failure

Step no.: 12.2
FL-D2-ST-CL-TM-

Select the events for which the buzzer must be activated.

FL = flush alarm (number of completed flush attempts)
D2 = dosing tank 2 empty
ST = stop
CL = check clock
TM = maximum temperature

Alarm relay

The following steps are only programmable if in step 7 the output function "AL" has been selected.

Only those options can be programmed for which a threshold limit has been entered in the previous program steps or for which the related input function has been selected.

Step no.: 12.3
MI-MA-D1-FB-PF-

Select the events for which the alarm relay must be activated.

MI = minimum conductivity
MA = maximum conductivity
D1 = dosing tank 1 empty
FB = flushing blocked
PF = power failure

Step no.: 12.4
FL-D2-ST-CL-TM-

Select the events for which the alarm relay must be activated.

FL = flush alarm (number of completed flush attempts)
D2 = dosing output 2 empty
ST = stop
CL = check clock
TM = maximum temperature

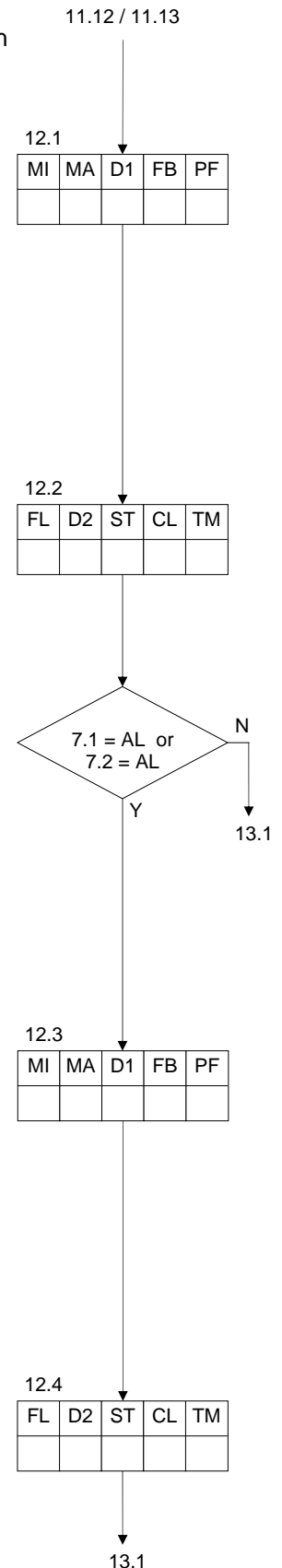

13. Code number

Step no.:	13.1
Codenumber	<u>0</u>

If a code number has already been defined as a protection against unauthorised changes in the programming, you must enter this code number before you can select step 13.2.

Step no.:	13.2
Codenumber	Y/ <u>N</u>

Enter whether the code number must be set.

Step no.:	13.3
Codenumber	<u>0</u>

Enter the code number between 0 – 9999.

Step no.:	13.4
Change code	Y/ <u>N</u>

If you have entered changes in program step 13.3 you have to confirm once more that you want to carry out the entered changes.

ATTENTION : Did you make a note of the code number ?

14. Flow pulse

Step no.:	14.1
Flow factor	x <u>1</u>

Enter a factor for the flow pulse output between “:10” – “x10”.
By means of this factor the number of incoming water meter impulses can be converted into more or less outgoing impulses.

Example :
Flow factor = x3 : Every incoming impulse creates three outgoing impulses
Flow factor = :2 : After two incoming impulses one outgoing impulse is created.

Step no.:	14.2
Time low	0. <u>5</u> s

Enter a time between 0.2 – 999.9 seconds when the output is not short-circuited.

Step no.:	14.3
Time high	1. <u>0</u> s

Enter a time between 0.2 – 999.9 seconds when the output is short-circuited.

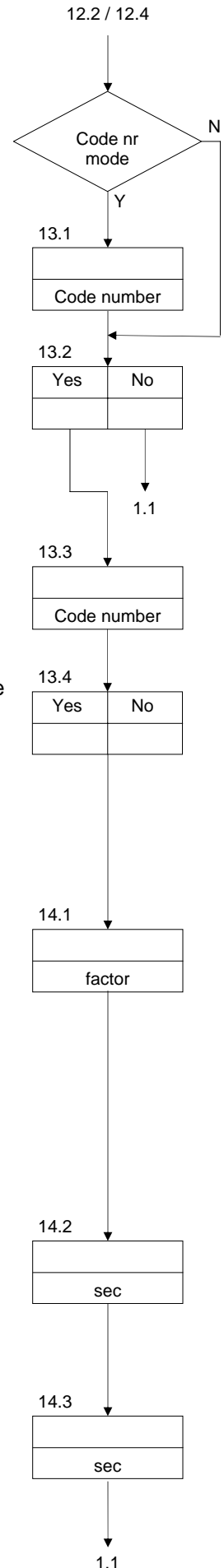

Connection terminals AS3037

AS3037 - 24 V :
Only earth terminal 29
no control lamp in the main switch

Only AS3037 115/24 V and 230/24 V

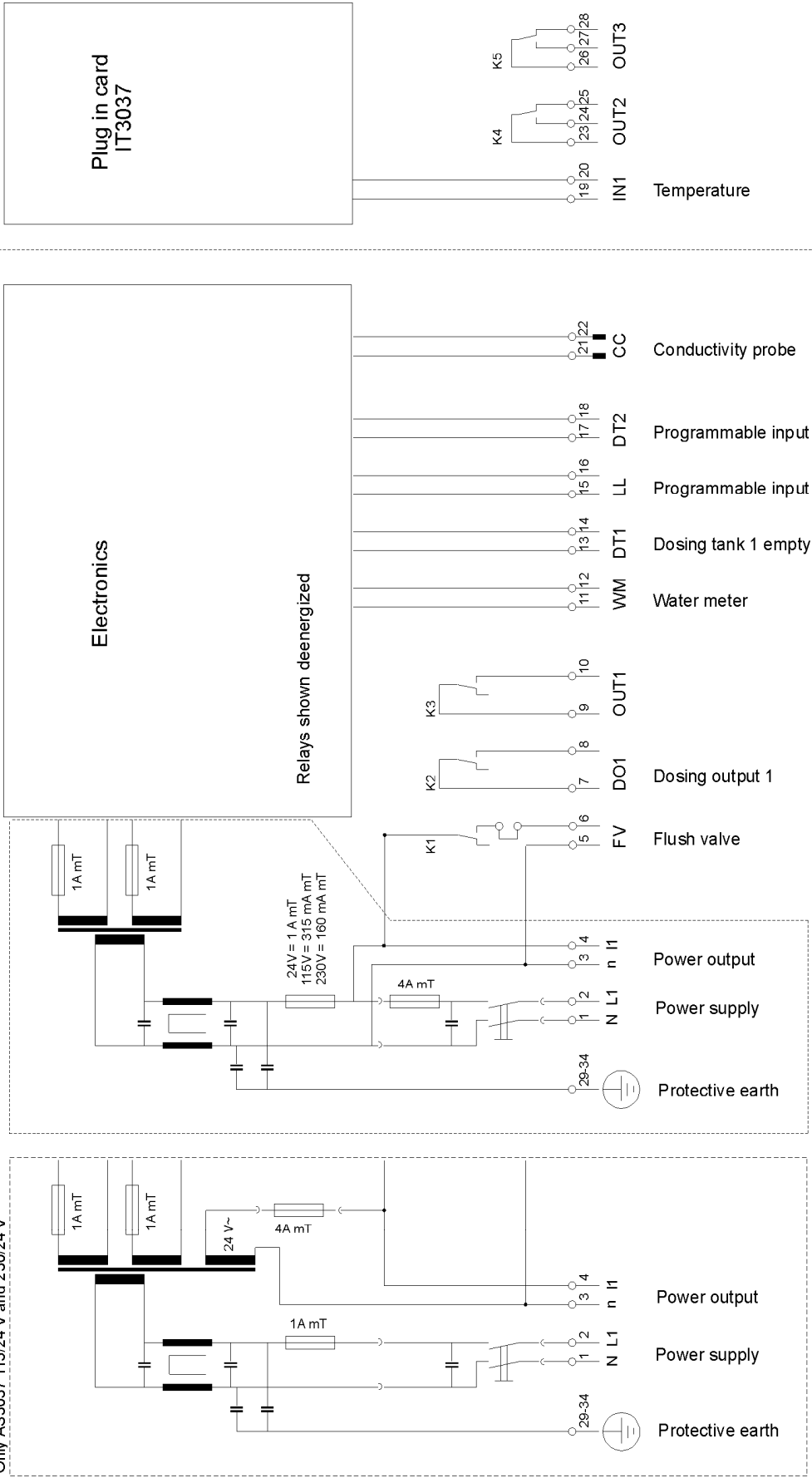



Technical data



Electrical supply :	24V	± 10%	50-60 Hz	fuse 4AT
	115V	± 10%	50-60 Hz	fuse 4AT
	230V	± 10%	50-60 Hz	fuse 4AT
	115/24V	± 10%	50-60 Hz	fuse 4AT
	230/24V	± 10%	50-60 Hz	fuse 4AT
Power consumption :	9VA			
Voltage-carrying outputs:	24V, 115V, 230V			: Total continuous current 4 A
	115/24V, 230/24V			: Total continuous current 2 A
Potential-free outputs :	Max load capacity 250V, 4A			
Inputs :	Load capacity 9V, 8 mA			
Protection class :	IP65			
Ambient temperature :	0 – 50 °C			
Weight :	Approx. 2.8 kg			
Dimensions :	W x H x D = 211 x 185 x 95 mm			
Particulars :	Device is protected against zero voltage			



Declaration of conformity

Declaration of conformity of the product with the essential requirement of the EMC directive 89 / 336 / EEC.

Product description

Product name : Controller for cooling tower
Product type : AS3037IT
Manufacturer : EWS Equipment for Water treatment Systems International B.V.
Paardskerkhofweg 14
NL-5223 AJ 's-Hertogenbosch
The Netherlands

Product environment

This product is intended for use in residential en light industrial environments.

Emission standard : EN 55011
Immunity standard : EN 50082-1
Electrical Safety : EN 60204
Low voltage directive : 2006/95/EG

Report

Report number : EWS / EMC / AS3037IT

This declaration was issued by :

Date : 26 – 09 - 2012

Name : D.H. Naeber

Signature :



FIVE-YEAR CONTROLLER LIMITED WARRANTY

LIMITED WARRANTY

EWS International (hereafter EWS) warrants her products free from defects in material and workmanship under the following terms.

In this warranty, "Products" shall be taken to mean all devices that are supplied pursuant to the contract with exception of software.

VALIDITY OF THE WARRANTY

Labour and parts are warranted for five years from the date of the first customer purchase. This warranty is only valid for the first purchase customer.

Notwithstanding the warranty period of five years as mentioned above - while upholding the remaining provisions – a warranty period of three months applies to the supply of software.

COVER OF THE WARRANTY

Subject to the exceptions as laid down below, this warranty covers all defects in material or workmanship in the EWS products. The following are not covered by the warranty:

- 1) Any product or part not manufactured nor distributed by EWS. EWS will pass on warranty given by the actual manufacturer of products or parts that EWS uses in the product.
- 2) Any product, on which the serial number has been defaced, modified or removed.
- 3) Damage, deterioration or malfunction resulting from:
 - a) Accident, misuse, neglect, fire, water, lightning or other acts of nature.
 - b) Product modification or failure to follow instructions supplied by the products.
 - c) Repair or attempted repair by anyone not authorized by EWS.
 - d) Any shipment of the product (claims must be presented to the carrier)
 - e) Removal or installation of the product
 - f) Any other cause, which does not relate to a product defect.
 - g) Cartons, equipment enclosures, cables or accessories uses in conjunction with the product.

FINANCIAL CONSEQUENCES

EWS will only pay for labour and material expenses for covered items, proceed from repairs and updates done by EWS at the EWS location. EWS will not pay for the following:

- 1) Removal or installations charges at customers and/or end user location.
- 2) Costs for initial technical adjustments (set-up), including adjustment of user controls or programming.
- 3) Shipping charges proceed from returning goods by the customer. (Shipping charges for returning goods to the customer are for the account of EWS).

All the costs which exceed the obligations of EWS under this Warranty, such as, but not limited to, travel and accommodation costs and costs for assembly and dismantling are for the account and risk of the customer.

WARRANTY SERVICE

In order to retain the right to have a defect remedied under this warranty, the customer is obliged to:

- 1) Submit complaints about immediately obvious errors related to the products delivered, in writing within eight days of the delivery of the products and submit complaints about shortcomings relating to the products delivered, which are not visible, within eight days of their being discovered.
- 2) Return defected products for account and risk of the customer. Costs for this shipment will not be reimbursed by EWS. The products may only be returned following express, written permission from EWS. Returning the products does not affect the obligation to pay the invoiced amounts.



- 3) Present the original dated invoice (or a copy) as proof of warranty coverage, which must be included in any [of the] return shipment of the product. Please include also in any mailing a contact name, company, address and a description of the problem(s).

LIMITATION OF IMPLIED WARRANTIES

Except where such disclaimers and exclusions are specifically prohibited by applicable law, the foregoing sets forth the only warranty applicable to the product, and such warranty is given expressly and in lieu of all other warranties, express or implied, or merchantability and fitness for a particular purpose and all such implied warranties which exceed or differ from the warranty set forth herein are hereby disclaimed by EWS.

EXCLUSION OF DAMAGES

EWS' liability for any defective products is limited to the repair or replacement of the product at our option. Except where such limitations and exclusions are specifically prohibited by applicable law EWS shall not be liable for:

- 1) Damage to other property caused by defects in the EWS product, damages based upon inconvenience, loss of use of the product, loss of time, commercial loss or:
- 2) Any damages, whether incidental, [consequential or otherwise] special, indirect or consequential damages, injury to persons or property, or any other loss.

Under no circumstances whatsoever shall EWS be obliged to provide compensation beyond the direct damage incurred by customer up to an amount not exceeding the payment receivable from the insurer of EWS in connection with the damage.

APPLICABLE LAW AND DISPUTES

- 1) Dutch law shall govern all offers made by EWS and all agreements concluded between EWS and customer. This warranty explicitly excludes application of the Vienna Sales Convention (CISG).
- 2) All disputes which may arise between the parties shall be dealt with exclusively by the competent court of law in the Netherlands under whose jurisdiction EWS falls. However, EWS reserves the right to submit any disputes to the competent court in the customer's location.