ES2030 SV

Control for ion exchangers and filter systems



Instruction manual

Software version 3.00

Contents

Functional description	1
Illustration	2
Service and regeneration displays	3
LED indicator lights.....	3
LCD display.....	3
First line.....	3
Second line during service.....	3
Second line during regeneration.....	3
Displaying and altering program values	4
Hardness of supply water / filter capacity.....	4
Current time.....	4
Info key	5
Flush.....	5
Regeneration time.....	5
Regeneration restrictions.....	5
Additional program run.....	5
Filter capacity.....	5
Water delivery.....	6
Input states.....	6
Output states.....	6
Service number.....	6
Software version.....	6
Programmed inputs.....	6
Programmed outputs.....	6
Last regeneration.....	6
Regeneration ratio.....	6
Messages	7
Capacity exceeded.....	7
Power failure.....	7
Refill regeneration medium.....	7
Delayed regeneration.....	7
Stop regeneration.....	8
Stop service.....	8
Minimum regeneration interval.....	8
Cancel buzzer	8
Switching the OUT1 and OUT2 relays on and off	8
Additional output function.....	8
Regeneration cycle function.....	8
Supply pulse function.....	8
Warning function.....	8
Desalinate function.....	8
Initiating regeneration manually	9

Special functions	9
Filter change over without program initiation.....	9
Immediate stop.....	9
Regeneration of standby filter.....	9
Switching from parallel to alternate.....	10
Fast cycle.....	10
Regeneration without initialisation.....	10
Regeneration of Filter 1 ONLY.....	10
Regeneration of Filter 2 ONLY.....	10
Displaying and modification of the basic settings	11
General information on programming and language settings.....	11
1 Filter switching.....	12
2 Electrical control.....	14
3 Number of regeneration switch phases.....	15
4 Single valve control.....	15
5 Regeneration times.....	16
6 Delayed regeneration.....	17
Starting on real time clock.....	18
7 Interval start of regeneration.....	18
8 Minimum regeneration distance.....	19
9 Definition of input functions.....	20
10 "Water meter" input.....	21
Filter capacity.....	22
11 "Stop service" input.....	22
12 "Start regeneration" input.....	23
13 "Chemical shortage" input.....	23
14 "Stop regeneration" input.....	23
15 Definition of output functions.....	24
16 "Additional program" output.....	25
17 "Regeneration" output.....	25
18 "Flow pulse" output.....	26
19 "Warning" output.....	26
20 "Desalinate" output.....	27
21 Buzzer.....	27
22 Programming mode.....	27
Examples of systems	28
Typical electrical wiring diagrams	29
Wiring diagram ES2030 SV	31
Notes on installation and initial use	32
Technical data	33
Declaration of conformity	34



Functional description

The controller ES2030 SV (wall mounted) is used for the automatic control and monitoring of single and double filter systems.

If additional control functions are required, they can be obtained with the IF2030 card, which can also be installed subsequently.

The software's flexible programming capacity and the individually adaptable hardware make a wide range of uses in water treatment systems possible. In combination with individual valves, these control units can operate ion exchanger systems and filter systems.

For single filter systems, 6 (or 8, if the IF2030 card is fitted) relays are available for controlling individual valves or for controlling pilot valves or control motors of a multifunction valve.

Since only 6 (or 8) relays in total are available for dual filter systems too, individual valve systems can only be operated as simple backwashing filters.

NOTE: For the sake of simplicity, in these instructions the treatment process carried out by a filter system (e.g. deferrization) is also referred to as "REGENERATION", as is usual in the case of ion exchangers.

A regeneration can be initiated :

1. by manual switch
2. by remote switch (water hardness monitor, conductivity meter, manual switch, etc..)
3. by pre selected amount (pulse water meter required)
4. after set time intervals (e.g. every 72 hours)
5. starting on real time clock

A time window can be set to determine times when regeneration must not take place (delayed regeneration).

A minimum regeneration distance between regenerations prevents regenerations being initiated constantly if the water meter or the remote switch is faulty.

Terminal diagram of ES2030 SV

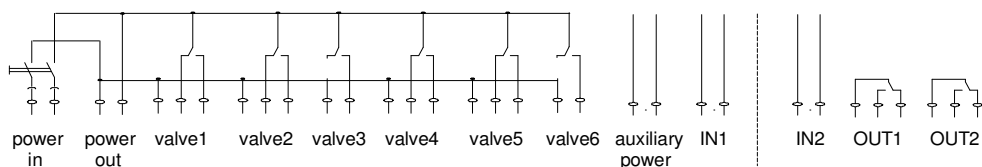

6 relays for magnetic valves or servo-motors (valve 1 – valve 6)

1 signal input, programmable for the following functions : water meter, stop, start or chemical shortage

1 12V= output for an external electronic application, e.g. turbines with Hall effect switch (auxiliary power)

1 power output for "control on" message and power supply to the potential free contacts "OUT1" and "OUT2" (power out)

Separately available card IF2030 :

1 signal input, programmable for the following functions : water meter, stop, start or chemical shortage

2 output relays programmable for the following functions : magnetic valves, additional program, regeneration, flow pulse, warning or desalination. (OUT1 and OUT2).

Illustration

Wall-mounted

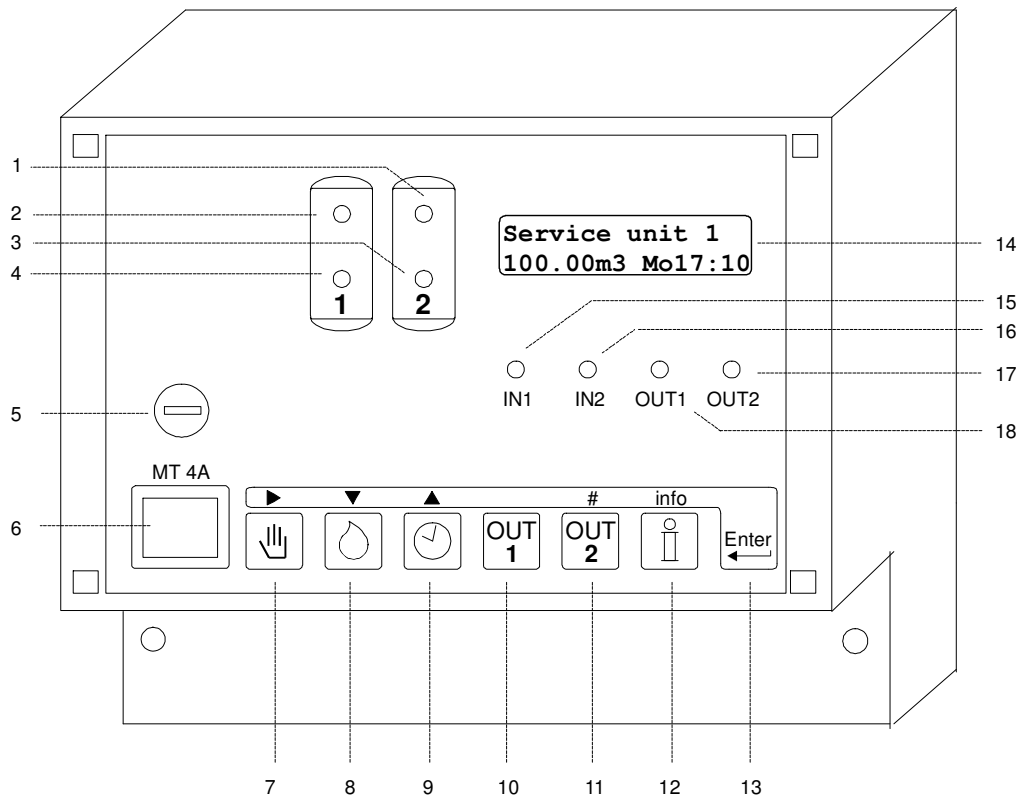

- | | | | |
|-------------------------|----------------------|----------------|-----------------|
| 1 Service filter 2 | 6 Main switch | 11 Output 2 | 16 Input 2 LED |
| 2 Service filter 1 | 7 Start regeneration | 12 Information | 17 Output 2 LED |
| 3 Regeneration filter 1 | 8 Supply water | 13 Programming | 18 Output 1 LED |
| 4 Regeneration filter 2 | 9 Time | 14 LCD display | |
| 5 Main fuse | 10 Output 1 | 15 Input 1 LED | |



Service and regeneration display

LED control lamps

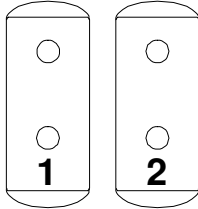

Coloured control lamps show the unit's major states :

Filter 1 service	(green)
Filter 2 service	(green)
Filter 1 regeneration	(orange)
Filter 2 regeneration	(orange)



IN1 = Input 1 active	(orange)
IN2 = Input 2 active	(orange)
OUT1 = Output 1 active	(orange)
OUT2 = Output 2 active	(orange)

LCD display

First LCD line

Service unit 1
100.00m3 Mo12:00

The first line of the LCD display shows the present state of the system, e.g. "Filter1 in service", "Filter 2 in regeneration" or "not in service".

Second LCD line during service

Service unit 1
100.00m3 Mo12:00

The second line of the LCD display shows the following information during service:

1. The amount of water remaining until the next regeneration

or:

The time of the next regeneration if a 'delayed regeneration' has been initiated (see program step 6).

or:

The number of hours until the next regeneration (see program step 7).

or:

Alternating with the 'amount of water remaining' of the current through flow (see program step 10.1 : pulse count)

or:

The flushing time remaining (see program step 19)

or:

"No Autom. Reg" if no automatic initiation of regeneration was selected (water meter, time interval).

2. The current time

Second LCD line during regeneration

Regener. unit 1
Phase : 2 80/100m

During regeneration, the second line of the LCD display shows the remaining time for the current phase and after the oblique the remaining time for the whole regeneration.

Or:

Alternating with the regeneration times, the remaining time for the additional program (see program step 15).



Displaying and altering program values

The main program values can be displayed and altered if required by pressing a key.

Hardness of supply water / filter capacity

Press the key with the symbol . In the case of an ion exchanger the bottom line will show the present supply water hardness, for a filter system it will show the capacity entered. (see program step 10.3).

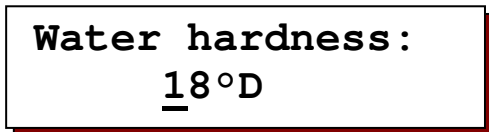

If you wish to change the value shown, use the '▶' key to move the cursor under the figure to be changed, and change the value with the number key ('#').

The following values may be entered, according to the units entered at phase 10.3 of the basic programming:

Unit of the supply water hardness :	entry value :
°D	2 - 99
°F	4 - 199
°E	2 - 99
mg/l CaCO ₃	40 -1999
gpg	2 - 99
no unit	0,01 - 9999,99 m3

(0,02 mmol/l = 0,10°D = 0,13 °E =0,18 °F
= 1,79ppm = 0,11gpg(USA) = 0,13gpg(UK))

The calculation of the soft water quantity with altered values is carried out at the start of each regeneration using the formula:

$$\frac{\text{Exchanger capacity (°D m}^3\text{)}}{\text{Supply water hardness (°D)}} = \text{soft water quantity (m}^3\text{)}$$

NOTE: In the case of remote control valves with water supply by-pass ports, the water meter records the dilution amount. The hardness of the diluted water must therefore be subtracted from the value to be entered.

Example :

Supply water hardness = 15 °D

Diluted water = 6 °D

This gives an input value of :

$$15 \text{ °D} - 6 \text{ °D} = 9 \text{ °D}$$

Current time

Press the time key with the symbol . The current time appears in the lower line.

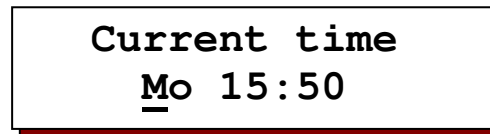

If you wish to change the value shown, use the '▶' key to move the cursor under the digit to be changed, and change the value with the number key ('#').



Info key

The information key is used to display various information and values. Only the service telephone number can be changed using the info key.



If the info key is pressed during programming, the full texts of some abbreviated texts are shown in the LCD display.

Flushing

Flushing
5001 5001 20s

The following values are shown :

Top right : Flush time in seconds

Bottom left : quantity of water remaining before flushing

Bottom right : quantity of water between two flushes.

NOTE: This display shown only if the flushing function is selected (see program step 15).

Regeneration time

Regen.time
Σ95m rest.0m

The total time for a regeneration cycle is shown.

Regeneration restrictions

NoReg16:00-18:00
IntRg72 MinRg4

NoReg 16:00 – 18:00

If “delayed regeneration” was selected during programming at step 6, the period in which no regeneration is to occur is shown.

Otherwise “NoReg ----” is displayed.

IntRg 72

If “interval start” was selected during programming at step 7, the time interval in hours is shown.

Otherwise “IntRg --” is displayed.

MinRg 4

If a “minimum regeneration distance” was selected during programming at step 8, the time interval in hours is shown.

Otherwise “MinRg --” is displayed.

Additional program

Additional prog.
Phase: 2 20

Bottom left : the starting point of the additional program is shown.

Bottom right : the start time entered is shown or the time remaining if the additional program is currently running.

If phase ‘0’ is displayed, the additional program will first run for its full time, followed by the regeneration program.

If phase ‘E’ is displayed the regeneration program will first run completely, then the additional program.

NOTE: If the additional program function was not selected during programming at step 14, “no additional program” will be displayed. If the IF card is not fitted this display will be omitted.

Filter capacity

Unit capacity
100m3

The water quantity delivered by a filter between two regenerations is shown. In the case of ion exchangers, the calculation is always carried out using the currently entered values for filter capacity and the supply water hardness.

Water delivery

Treated water
0.1m3

The total quantity of water delivered by the system is shown.

Input states

Input
WM-ST-

Indicates the current state of each input.
(- = Input not activated, | = Input activated)
WM = Water meter SP = Stop service
ST = Start regeneration CH= Chemicals shortage
HO = Stop regeneration

Output states

Output 12345678
 - | --- | --

The current switch states of the output relays are shown. Each figure has a relay allocated to it (see switching diagram on p.31).
A horizontal stroke '-' under a figure means 'relay switched off'.
A vertical stroke '|' under a figure means 'relay switched on'.

NOTE: Relays 7 and 8 are only shown if an IF card is fitted.

Service number

Service
0031 73 443755

A service phone number is displayed. You can also change the number here.

Change the phone number :

Select number : ►
Lower number : ▼
Higher number : ▲

Software version

Softwareversion
ES2030sv 2.01.00

The software is continuously updated by the factory. Where necessary changes are made

to reflect new technology and customer requirements.
The number of the version currently installed is displayed.

Programming the inputs

IN1=Water meter
IN2=prog.initi

The programmed functions of input IN1 (and IN2 if the IF2030 card is fitted) are displayed.

Programming the outputs

OUT1=Add. Progra
OUT2=Status

The programmed functions of output OUT1 and OUT2 are displayed.

NOTE: This display is only shown if the IF2030 card is fitted.

Last regeneration

last regenera.
3d 12h 15Min.

The display shows how much time has passed since the last regeneration.
For example : 3d 12h 15min
It has been 13 days, 12 hours and 15 minutes since the last regeneration.

Regeneration ratio

Relation
1:3/3

The regeneration ratio entered is displayed, and after the oblique the current state if filter 2's regeneration counter is shown.

Example 1: 1:3/2

Regeneration ratio of filter 1 : filter 2 = 1:3
Filter 1 has already been regenerated once.

Example 2: 1:3/1

Regeneration ratio of filter 1 : filter 2 = 1:3
Filter 1 has already been regenerated twice.
Both filters will be regenerated at the next regeneration.

NOTE: This display only appears where a connection in series with two filters and a regeneration ratio greater than 1:1 has been selected.



Messages

During service and during the regeneration of the system, various signals are given depending on the type of controller and its programming.

These signals can be signalled with the built-in buzzer and displayed in the LCD display. If the extension card IF2030 is installed an additional relay can be selected as warning relay (step 15).

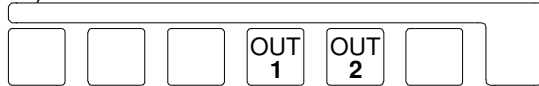

Press the key OUT1 or OUT2 to clear the buzzer and any activated warning relay. The LCD display is only cleared when the warning signal is no longer active.

Capacity exceeded

S T A T U S
Instal. exceeded

This display can only appear with a double filter system.

While one of the filters is regeneration, the other was also called on to regenerate. The warning in the LCD display is cleared when this filter starts regeneration.

Possible causes where activated by the water meter :

Incorrect setting of capacity, supply water hardness or of the water meter itself.

Overloading of the system e.g. by filling a large container.

Possible causes where activated externally by a water analysis device :

Saturation of a system newly put into use, caused by the negative ion effect.

Solution : fit a flushing valve or circulation pump. Reduce the sensitivity of the analysis Device.

Other possible causes :

Poor regeneration of the filter due e.g. to regeneration medium not being present or being incorrectly primed.

NOTE: In two-filter systems, after a flow dependent regeneration activation the regeneration of the second filter will follow immediately the current regeneration ends. However in the case of external activation of the regeneration, e.g. by a water analysis device, the regeneration does not follow, as it can be assumed that the hardness warning

occurred as a result of a standstill hardening of the standby filter. The second filter is only regenerated if the relevant start signal is still present at the end of the current regeneration or if it reset.

In the case of ion exchangers with a salt release valve, if no brine has yet formed for the second filter, stop the regeneration by switching off the unit.

Power failure

S T A T U S
Supply failure

No data are lost if there is a power failure. When power is restored the control panel will return to the same setting with the same values.

NOTE: If the system is at the regeneration setting when power is lost, the filter may become over saturated again if the water pressure continues during this time and it is washed by supply water over a period of hours.

If so, stop the regeneration and then re-start.

Refill regeneration medium

S T A T U S
Refill RegMedium

Refill regeneration medium.

NOTE: An imminent regeneration will not be carried out unless either regeneration medium is again available or the "start regeneration" key with the symbol  is pressed.

In the case of alternately operating two filter systems, the unit switches over to the standby filter.

Delayed regeneration

S T A T U S
Prohibited Reg.

The required regeneration will not start until the time shown in the LCD display. However the regeneration can be started immediately by pressing the "start regeneration" key (). This display is only shown if activation of "delayed regeneration" was selected in step 19 or 21.

Stop regeneration

S T A T U S
StopRegeneration

This warning may have various causes depending on the function of the switch contact connected, for instance two controls may be blocking each other, or the control pressure for a pneumatic valve may have been cut off. Find the cause.

In alternately operating two filter systems, if the "Stop" warning is already displayed at the start

of a regeneration cycle the unit switches over to the standby filter.

NOTE: The stop signal can be cancelled for the duration of the regeneration cycle by pressing the 'start' key with the  symbol. Regeneration then continues.

Stop Service

S T A T U S
Stop service

This display only appears if activation of "stop service" was selected at program step 19 or 20. The LCD display is cleared automatically as soon as the input signal is no longer present.

Minimum regeneration distance

S T A T U S
Min. regen. period

Possible causes if activated by the water meter:

Incorrect setting of capacity, supply water hardness or of the meter itself. Overloading of the system e.g. by filling a large container. Possible causes where activated externally by a water analysis device.

Saturation of a system newly put into use, caused by the negative ion effect.

Solution: fit a flushing valve or circulation pump. Reduce the sensitivity of the analysis device.

NOTE: You determine at program step 8.3 whether regeneration is to follow automatically at the end of set "minimum regeneration distance" or whether the next regeneration has to be started manually.

NOTE: The message in the LCD display is not cleared until regeneration is started.

Cancel buzzer

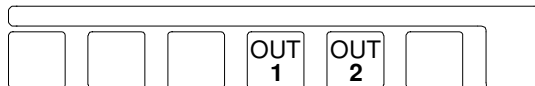

If the built-in buzzer sounds, it can be cancelled immediately by pressing the 'OUT1' or 'OUT2' key.

Switching the OUT1 and OUT2 relays on and off

If the controller has been fitted with the IF expansion card, the two additional relays with the functions selected at program step 14 may be switched on and off manually by pressing the relevant key for approx. 5 seconds.

The 'OUT1' key is assigned to relay 7 and the LED display 'OUT1'. The same applies to 'OUT2' and relay 8.

'Additional program' function

The relay can be switched on and off during the 'service' or 'regeneration' phases. The test function is automatically deactivated at the beginning and end of a regeneration.

'Regeneration' function

The relay can be switched on and off (e.g. for control purposes) during the 'service' phase. It

is switched off automatically at the end of a regeneration.

'Flow pulse' function

The relay is switched on for the length of time set at program step 17.

'Warning' function

The relay is switched on (e.g. for control purposes) for as long as the key is pressed. If the relay has been switched on by a warning the relay is cleared.

'Flush' function

The relay is switched on for the length of time set at program step 19.

If a flush cycle is already running, it can be stopped prematurely.



Initiating regeneration manually

A regeneration cycle can be initiated manually at any time pressing the 'Start' key with the symbol . Regeneration of the filter in service commences after six seconds.

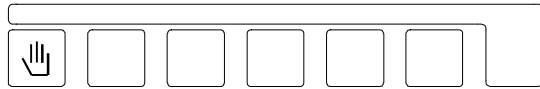

- In the case of systems operating alternately, the standby filter is put into service.
- If 'delayed regeneration' was selected at step 6.1 of the programming, the time function is activated and the time at which the delayed regeneration will be initiated automatically is displayed at the bottom left of the LCD display.
- No regeneration is yet initiated.

- If the time function for 'delayed regeneration' has already been activated (and the time regeneration will be initiated is already displayed at the bottom left of the LCD display), regeneration will be initiated after four seconds regardless of the time shown.
- The filter's flow counter is reset to full capacity after regeneration.
- If initiation at intervals was selected at step 7.1 during the input of basic values, the hour interval meter is set to its preset interval.
- If a minimum regeneration interval was selected at step 8.1 during the input of basic values, the timer for the regeneration interval is reset.

Special functions

These functions should only be used by a professional water treatment specialist, as their improper use may lead to malfunctions.

Filter change over without program initiation

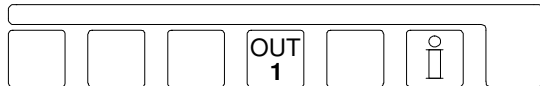

Simultaneously press the function keys with the symbols and . Change over of the filters will take place after 4 seconds on two filter systems.

NOTE: Separate flow counters are used for each filter. Where an almost saturated filter is switched into the standby position, it may happen that regeneration becomes necessary shortly after it has been brought into service, and this may be at a time when the other filter is still regenerating. In this event, the fault warning 'capacity exceeded' appears.

NOTE: Multi stage valves which have no connection to return them automatically to the service setting will remain at a regeneration setting and are no longer synchronized with the control panel.

Regeneration of standby filter

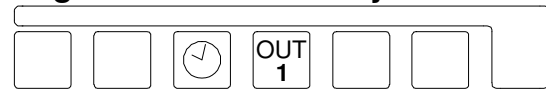

Simultaneously press the function keys with the symbols and . The regeneration of the standby filter will begin after 4 seconds on two filter systems

NOTE: this only applies for alternate filter service (program step 1.3 = YES).

Immediate Stop

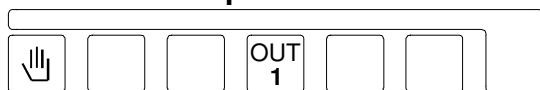

Simultaneously press the function keys with the symbols and .

Any regeneration program running will stop after 4 seconds and the system will be switched into service position.



Switching from parallel to alternate

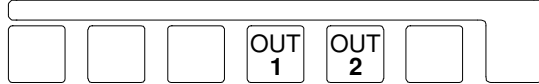

If parallel switching was selected when programming filter switching at program step 1.4 then it is possible to switch over to alternate service. When this is done, the filter which has the least capacity remaining is first to regenerate.

Bear in mind that the other filter has also become partially saturated, so that the system may become overloaded after it is switched to alternate service. It is therefore best to start a regeneration manually after switching over. Press the 'OUT1' and 'OUT2' keys simultaneously.

Fast cycle



Simultaneously press the function keys with the symbols and .

After 3 seconds the internal program clock switches over from minute pulses to second pulses. The fast cycle activated only affects the current regeneration phase, the following phases will run at normal speed.

NOTE: If you want to cycle through the various regeneration phases using the fast cycle, wait for two or three minutes after each stage to allow all the valves to move into their new positions.

NOTE: If regeneration medium has already been primed, the filter must be rinsed before the system is put into service.

Regeneration without initialisation



For maintenance purposes it is sometimes necessary to check the regeneration program without initialising the pulse counter or recalculating the filter capacity. Simultaneously press the function keys with the symbols and .

In single filter system, the service filter will be regenerated after 4 seconds without initialisation and without recalculation of the filter capacity.

In two filter systems the standby filter will be regenerated and the displayed capacity values will not be changed.

If the service filter is to be regenerated, a 'filter exchange without program initiation' must be carried out first.

NOTE: This only applies for single filter and alternating filter service.
(Program steps 1.1, 1.2 or 1.3 = YES).

Regeneration of Filter 1 ONLY

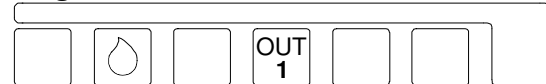

Simultaneously press the function keys with the symbols and .

After 4 seconds, Filter 1 only will be regenerated without initialisation and without recalculation of the filter capacity.

NOTE: This only applies for series or parallel connection (program steps 1.4 or 1.6 = YES).

Regeneration of Filter 2 ONLY



Simultaneously press the function keys with the symbols and .

After 4 seconds, Filter 2 only will be regenerated without initialisation and without recalculation of the filter capacity.

NOTE: This only applies for series or parallel connection (program steps 1.4 or 1.6 = YES).



Display and modification of the basic settings

General information on programming and language selection

On first use, the controller is adjusted to the operating data of the water treatment system by entering basic settings. These settings can be changed and are not lost if power is cut off.

NOTE: All the relevant data can be changed in programming mode 0. In programming mode 1 only some of the data can be changed, and in programming mode 2 the cannot be changed without specialist knowledge (see program step 22).

- Any alteration to the basic settings should be carried out by an authorized specialist engineer.

- Make a note of the basic settings in the empty spaces in the flowcharts below and keep this manual carefully for the use of service and maintenance staff.

- The basic settings can be changed at any time. However most changed settings can only be activated after the start of the next regeneration.

- Some keys have a double function. In programming modes, the ►, ▼, ▲ and # keys are used in combination with the Enter key.

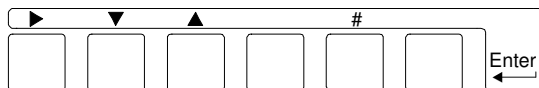

1. Press the Enter key.

To avoid accidental programming changes, the key has to be held down for 4 seconds before the basic values are released for change.

The LCD display first shows the following message.

Attention!
Programmechange

After 4 seconds this changes to:

Start
Programmechange

NOTE: Continue to hold down the Enter key for functions 2 and 3.

2. At this point you can change the language of the LCD display as follows:

Press '#' key.

Use the ► key to move the cursor under the abbreviation for the desired language.

English
D Nl E F Es I

3. You can move on to the first and subsequent programming steps using the ▼ key

4. You can move back to previous steps with the ▲ key.

NOTE: The controller is now in programming mode, and the Enter key should now be released. To leave programming mode, press the Enter key again. The controller will also exit programming mode automatically approximately 2 minutes after the last key has been pressed.

5. The cursor is moved with the ► key. Yes/No questions are answered by placing the cursor under Y for Yes and N for No. For numerical entries use the cursor to select the digit to be changed.

6. The numerical settings selected with the cursor can be changed within the preset values by pressing the '#' key.

NOTE: Programming must be carried out with the filter in the service position. During a regeneration there is no programming possible.

1. Filter switching

Single filter 1

Step no. : 1.1
SingleFilter1Y/N

If you enter 'YES' the system consists of 1 filter.

Single filter 2

Step no. : 1.2
SingleFilter2Y/N

If you enter 'YES' the system consists of 1 filter.

The ability to select between 'Filter 1' and 'Filter 2' allows a two filter system to be reset quickly to single filter service (for repair work or low water demand).

Alternating service

Step no. : 1.3
2-tank alter.Y/N

A two filter system normally runs in alternating mode, with one filter supplying treated water while the other filter is in reserve (standby) or is being regenerated.

Parallel service

Step no. : 1.4
Parallel servY/N

If high output performance is required over a short period, a two filter system can also be run in parallel. Here both filters supply treated water at the same time except during a regeneration.

When the controller is programmed for parallel service, it can be switched back and forward between alternating and parallel modes using the special function 'Switching from parallel to alternate'.

Valve control for alternate service and parallel service can be entered at 4.1. For this, the controller must first be programmed for alternate service (1.3 at Yes) and then for parallel service (1.4 at Yes).

Step no. : 1.5
Reg.Fi.1+2 Y/N

For parallel service you can determine whether the filters are to be regenerated one after the other or at offset intervals.

If you select 'Reg.Fi.1+2 Y/N' both filters will be regenerated immediately one after the other, since both filters are saturated.

For example: silica filter systems activated by time intervals or differential pressure gauges.

NOTE: For water softening systems it must be ensured that brine is available (reservoir tank or separate salt solution container).

If you select 'Reg.Fi.1+2 Y/N' only the saturated filter in service will be regenerated. At this point the other filter still has 50% of its capacity.

For example: Quantity controlled water softening systems at high outputs.

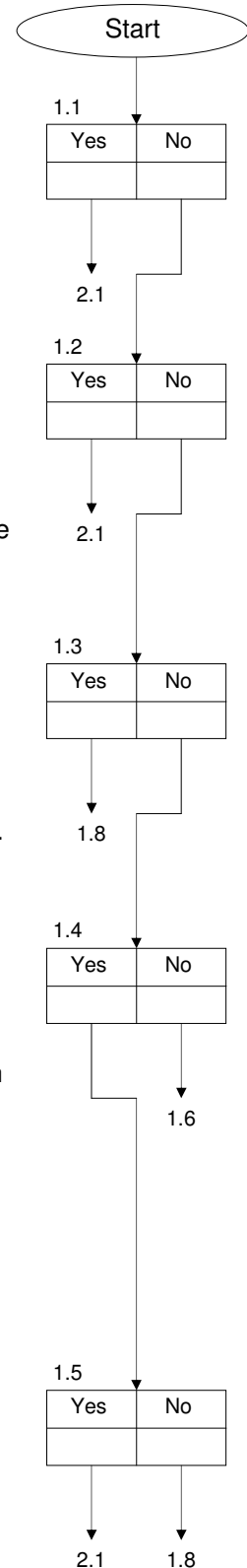



Series switching

Step no.:	1.6
Series connec<u>Y</u>/<u>N</u>	

Select series switching when the filters in a two filter system were set up in series. For example: single flow partial desalination system with an H exchanger and a Na exchanger.

Step no.:	1.7
Relation	1:<u>1</u>

For partial desalination systems the service life of the Na exchanger can be several times longer than of the H exchanger. You can therefore enter a regeneration ratio between 1:1 and 1:9.

For example, if you enter 'relation 1:2', the Na exchanger is only regenerated after every second regeneration of the H exchanger.

Service valve

Step no.:	1.8
Main valve on<u>Y</u>/<u>N</u>	

In 'alternating service' or 'parallel service', one filter continues to supply treated water while the other is regenerating. If it too becomes saturated because the amounts drawn off are too large, the message 'capacity exceeded' is displayed. You can determine whether in that case the second valve is to stay open, with the possibility that it will supply incompletely treated water (Main valve on Y/N) or whether that valve should close too (Main valve on Y/N), with the result that no water flows to the user until the regeneration is completed.

NOTE: The programming setting 'Stop in service' (program step 4.1 – SP) is activated if 'Main valve on = N' is set.

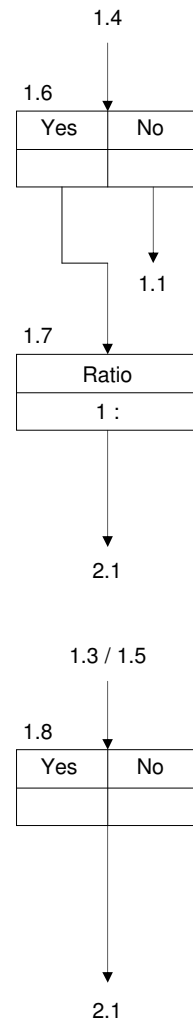



2. Electrical control

The controller can be expanded with this relay by fitting the IF expansion card (connector: OUT1 and connector OUT2).

ATTENTION: This program step can only be selected if the controller is fitted with the IF2030 expansion card.

Step no. :	2.1
V7_	V8-

In this step you can select the outputs OUT1 (V7) and/or OUT2 (V8) for magnetic valves.

(' - " : No magnetic valve connected; " | " : Magnetic valve connected)

If an output is selected for valve function the corresponding step in step 15 will be skipped.

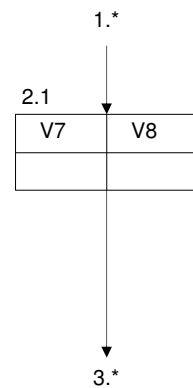



5. Regeneration times

Step no.:	5.1
Time phase₁:	10m

The number of regeneration switch phases for individual valve control was set at program step 3.1.

At this program step, enter the required times for each of the periods according to the number of regeneration phases. No times are entered for the service and stop positions.

Enter period number and the required time in the range from 1 to 990 minutes.

Examples where number of regeneration phases = 3 :

Backwashing period 1 : 10 minutes

Salting period 2 : 105 minutes

Washing out period 3 : 15 minutes

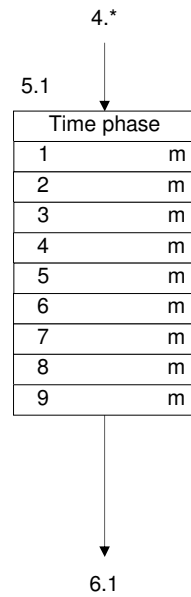

6. Delayed regeneration

Step no. :	6.1
Time Delayed Y/N	

A regeneration can be initiated at any time during the day. But it is often desirable not to have a regeneration during production times, since for instance the water pressure then may be insufficient for regeneration.

When 'delayed regeneration' is selected, a two filter system alternating service will switching to the standby filter.

Mo	Tu	We	Th	Fr	Sa	Su
<u> </u>						

Select the day(s) when the function 'delayed regeneration' must be activated. ("-" = not activated; "|" = activated).

Step no. :	6.3
Time1	6:00

Enter the first time, after which no regeneration is to be initiated.

Step no. :	6.4
Time2	18:00

Enter the second time, after which regeneration is again permitted

Example 1: Time1 = 6:00 Time2 = 18:00

No regenerations are initiated automatically between 6 a.m. and 6 p.m. of the same day.

Example 2: Time1 = 17:00 Time2 = 5:00

No regenerations are initiated automatically between 5 p.m. and 5 a.m. of the following day.

Step no. :	6.5
Main valve on Y/N	

With a 1 filter system, a 2 filter system connected in series and with a 2 filter system operating in parallel with sequential regeneration. It can be determined whether the service valve(or both service valves) should stay open until the regeneration time entered (Main valve on Y/N) or should be shut immediately (Main valve on Y/N).

If the service valve remains open, it should be ensured that the system can still supply treated water until the regeneration time.

In the case of a 2 filter system operating in parallel with delayed regeneration it is determined whether the service valve of the saturated unit remains open until the delayed regeneration (Main valve on Y/N) or if the service valve closes and only one filter is in service until the end of the delayed regeneration (Main valve on Y/N)

A 2 filter system in alternating service always switches over to the standby filter, and program step 6.5 cannot be selected.

NOTE: When 'Main valve on Y/N' the programmed setting 'Stop in service' (program step 4.1 – SP) is activated.

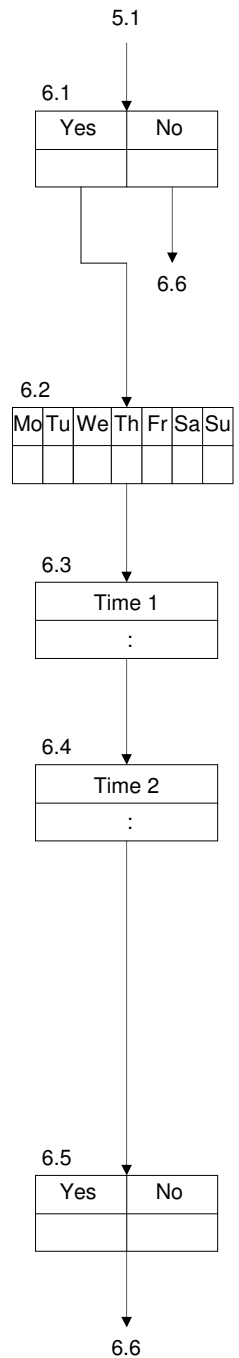

Starting on real time clock

Step no.:	6.6
Timestart	Y/<u>N</u>

A regeneration can be started depending on the real time clock. There is the possibility for programming two starting times at one day.

MoTuWeThFrSaSu
- - - - - - -

Select the day(s) for starting regeneration of the unit in service at the time programmed in step 6.8 (“-“ = not activated; “|” = activated).

Step no.:	6.8
Starttime	00:3<u>0</u>

Enter the time at which the unit in service will go into regeneration.

MoTuWeThFrSaSu
- - - - - - -

Select the day(s) for starting regeneration of the unit in service at the time programmed in step 6.10 (“-“ = not activated; “|” = activated).

Step no.:	6.10
Starttime	05:0<u>0</u>

Enter the time at which the unit in service will go into regeneration.

7. Interval start of regeneration

Regenerations can also be initiated at fixed intervals. This periodic initiation is selected where a water meter is not necessary because the amounts of water drawn off are constant.

It is also used to prevent micro organism formation where there would be excessive standby periods in the context of flow dependent or quality dependent initiations.

Step no.:	7.1
Interim start	Y/<u>N</u>

NOTE: In systems with salt solution containers you must wait for brine formation to take place. I.e. in that case the interval before the next regeneration should be at least 4 hours.

Step no.:	7.2
Period	7<u>2</u>h

An interval between 1 and 999 hours can be entered.

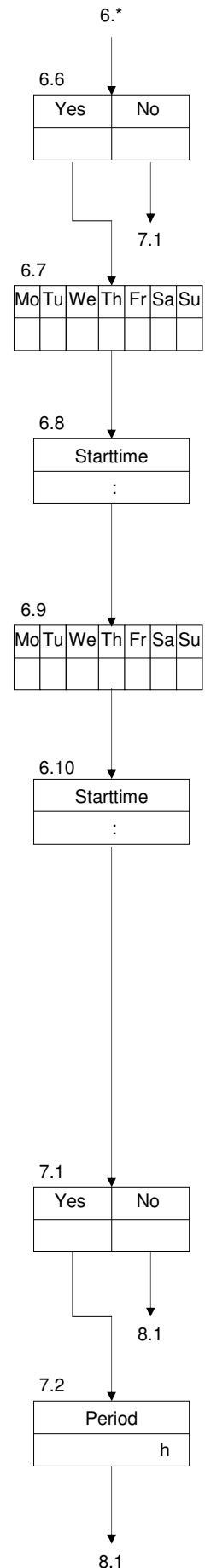

8. Minimum regeneration distance

Step no.:	8.1
Min.reg.time	<u>Y</u>/N

The minimum distance between two regenerations in ion exchangers can be calculated and monitored on the basis of the system's capacity and the maximum water demand.

If the treatment unit is additionally monitored using an automatic water hardness monitoring device, the minimum distance between regenerations must be programmed in, as otherwise any fault in the hardness monitoring device or the treatment unit (such as faulty priming of chemicals) may result in continuous regenerations.

This applies to filter systems monitored by a differential pressure gauge.

Step no.:	8.2
Period	<u>4</u>h

A setting between 1 and 999 hours can be entered as the minimum time distance between two regenerations.

If an attempt is made to initiate a regeneration automatically before the set time has elapsed (by water meter, time interval or analysis device), the appropriate message is shown on the LCD display, and the built-in buzzer sounds if programmed at program step 21.

Where the IF2030 card is installed, a warning relay can also be activated (program step 19).

Step no.:	8.3
Make up reg.	<u>Y</u>/N

You can determine whether the regeneration is to be carried out immediately after the end of the 'minimum regeneration distance' (Y/N) or whether the next regeneration has to be started manually.

Step no.:	8.4
Main valve on	<u>Y</u>/N

When the message 'minimum regeneration distance' is displayed, you can determine whether the valve of the system in service is to stay open until regeneration is initiated, with the possibility that it will supply incompletely treated water (Y/N) or whether that the valve should close (Y/N) with the result that the system does not supply any more water.

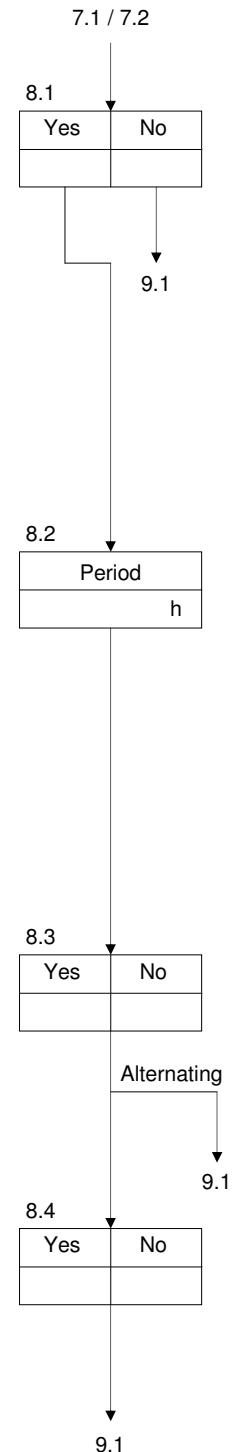

9. Definition of input functions

The controller is provided as standard with one input for one input function (connection IN1). If the IF expansion card is added, the controller is expanded with a second input for a further input function (connection IN2).

The inputs may be used alternatively for the following functions :

Water meter, Stop in service, Regeneration start, Chemicals shortage or Stop during regeneration.

Input function IN1

Step no. :	9.1
<u>WM</u> SP ST CH HO	

Place the cursor under the required input function.

- WM* = water meter
- SP* = stop service
- ST* = start regeneration
- CH* = chemicals shortage
- HO* = stop regeneration

Input function IN2

Step no. :	9.2
WM SP <u>ST</u> CH HO	

Place the cursor under the required input function.

NOTE : This program step can only be selected if the controller has been fitted with the IF expansion card.

Inputs active

Step no. :	9.3
IN1 <u> </u> IN2 	

You can determine whether the input contact is to be open or closed when the function is active.

- “ - “ = Contact open for activation.
- “ | “ = Contact closed for activation

NOTE: Where the input is selected for a water meter its function is not programmable as in that case the input is always active when the contact is closed.

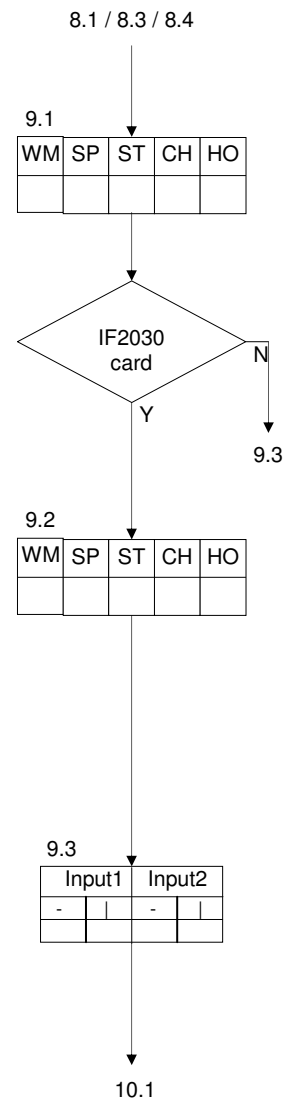



10. 'Water meter' input

The flow rate of the treated water is established using a pulse water meter, and when a preset amount has been delivered a regeneration is initiated. The amount of water remaining before the next regeneration is shown in the LCD display.

If an input was programmed for a water meter at program step 9.1 or 9.2, the pulse interval or pulse count of the water meter must be entered. For ion exchangers the unit of water hardness and the exchanger capacity of a filter at 1 degree of hardness must be set, and for filter systems the filter capacity of a filter.

Pulse interval / Pulse count

Step no. : 10.1
lit/imp--imp/lit

The pulse rate of the water meter can be entered as a pulse interval in litres/pulse or as a pulse count in pulses/litre.

Water meters without reducing gears (also known as turbines) emit a high number of pulses, and the technical data usually show impulses / litre.

NOTE: The current flow in m³/h is only displayed when the 'pulse / litre' unit is selected.

Step no. : 10.2
Imp.space 1001/p

Values from 1 to 9999 litres / pulse can be entered for the pulse interval of the water meter, and values from 0,01 to 655,00 pulses / litre for the pulse count.

Unit of supply water hardness

Step no. : 10.3
°D °F °E mg/l gpg ---

Move the cursor under the desired physical unit of supply water hardness.

NOTE : If no unit is selected, it is assumed that the system is a filter system and not an ion exchanger.

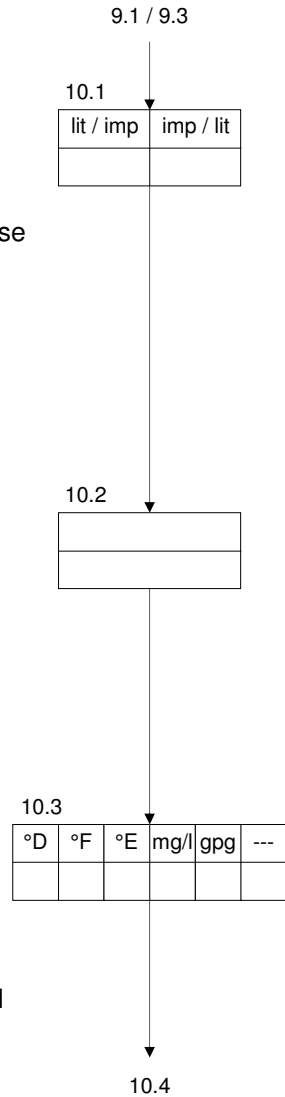



Filter capacity

Step no. :	10.4
Capacity	1800

ION exchanger

The physical unit of the filter capacity depends on the unit of supply water hardness selected at step 10.3. It gives the soft water amount in m³ for the hardness unit chosen.

The soft water amount per filter is calculated automatically as follows :

$$\frac{\text{Filter capacity (}^\circ\text{D m}^3\text{)}}{\text{Supply water hardness (}^\circ\text{D)}} = \text{soft water amount (m}^3\text{)}$$

Example 1:

$$\frac{1800 \text{ }^\circ\text{D m}^3}{18 \text{ }^\circ\text{D}} = 100 \text{ m}^3$$

Example 2:

$$\frac{2020 \text{ }^\circ\text{F m}^3}{18 \text{ }^\circ\text{F}} = 50,5 \text{ m}^3$$

A numerical value between 1 and 65535 can be entered for the filter capacity, where the hardness unit is mg/l CaCO₃ the values are from 10 to 655350.

Note: the capacity for a single filter is always entered, regardless of whether the system is made up of one or more filters.

FILTER SYSTEMS :

If no supply water hardness was selected at step 10.3 the capacity of one filter can be entered in the range 0,01 to 9999,99 m³.

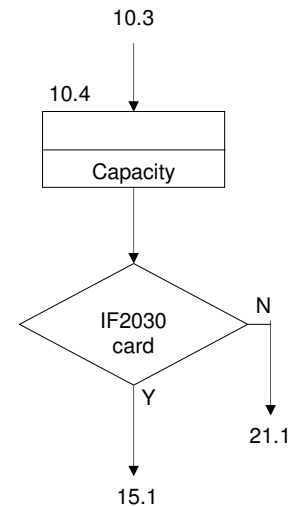

11. 'Stop service' input

This input can be used for instance to control the refilling of a reservoir tank. When the input is active then in accordance with programming at step 4 for individual valve control, the position 'stop in service' is activated instead of the service position.

NOTE: Program data are not entered for this function.



12. 'Start' input

This input can be used to start a regeneration of the currently operating filter externally with a key or a water analysis device.

In alternate filter service the standby filter is put into service.

If delayed regeneration was selected at step 6.1 of the basic values input, the time function is activated and the time at which the delayed regeneration will be automatically initiated is shown at the bottom left of the LCD display. No regeneration takes place immediately.

If a minimum regeneration distance was selected at step 8.1 of the basic values input, the if there is an attempt to start regeneration within the time distance entered the message 'minimum regeneration distance' is displayed and no regeneration is carried out (see 'warnings', page 8).

In single filter systems the input is blocked during regeneration and only released again 5 minutes after the end of the regeneration.

In double filter systems the input is only polled again 15 minutes after the start of a regeneration. If a start signal is present, the warning 'capacity exceeded' is displayed.

NOTE: The filter in service which issued the warning will only be regenerated if the start signal is still present or is resent at the end of the current regeneration.

NOTE: No program data are entered for this function.

13. 'Chemicals shortage' input

This input can be used to monitor the chemicals supply to ion exchangers. No regeneration is started. The system remains in the service position. Double filter systems in alternate service are switched over the standby filter.

However, a regeneration is still initiated despite chemicals shortage if the start regeneration key with the symbol  is pressed.

NOTE: The input is only activated to monitor chemicals three hours after the last regeneration. But if a regeneration is started during this period, the chemicals supply is checked immediately. No check is carried out during a regeneration.

NOTE: No program data are entered for this function.

14. 'Stop regeneration' input

Step no. : 14.1
Main valve onY/N

The regeneration is stopped and the Stop position programmed at program step 4 is activated.

The stop signal can be cancelled for the duration of the whole regeneration by pressing the Start key with the  symbol.

You can determine whether the valves of the system in service are in the 'service' position (Y/N, 4.1 - SV) or whether the valves are in the 'service stop' position (Y/N, 4.1 - SP) when the input 'Stop' is activated at the start of a regeneration.

Examples for use: delay of start of regeneration, extension of regeneration or interruption of regeneration (dependent on valves control).

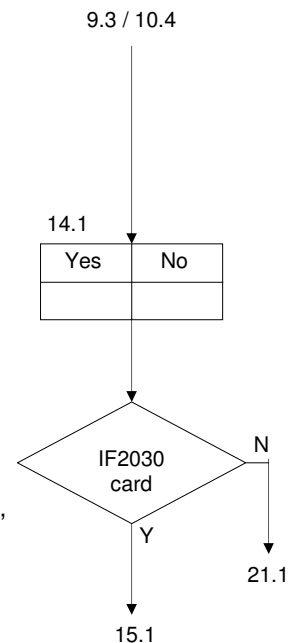



15. Definition of output functions

The controller is not equipped with the necessary additional relay for output functions as standard. The controller can be expanded with this relay by fitting the IF expansion card (connector: OUT1 and connector OUT2).

The outputs may be used for one of the following functions :

Each function can only be used once.

NOTE: Program steps 15-20 can only be selected if the IF expansion card has been installed in the controller.

Output relay 1

Step no. : 15.1 <u>AP</u> RG FP WA PU
--

Place the cursor under the required output function.

- AP = additional program
- RG = regeneration
- FP = flow pulse
- WA = warning
- PU = flushing

NOTE: The functions 'flow pulse' and 'flushing' can only be selected if the system is fitted with a water meter.

NOTE: This step will not be selected if the relay is programmed for valve function in step 2.1

Output relay 2

Step no. : 15.2 AP RG FP <u>WA</u> PU
--

Place the cursor under the required output function.

NOTE: The functions 'flow pulse' and 'flushing' can only be selected if the system is fitted with a water meter.

NOTE: This step will not be selected if the relay is programmed for valve function in step 2.1

Outputs active

Step no. : 15.3 OU1 <u>-</u> OU2 -

You can determine whether the output relays are to be energized or de-energized when the function is active.

- " - " = Function active when relay energized
- " | " = Function active when relay de-energized

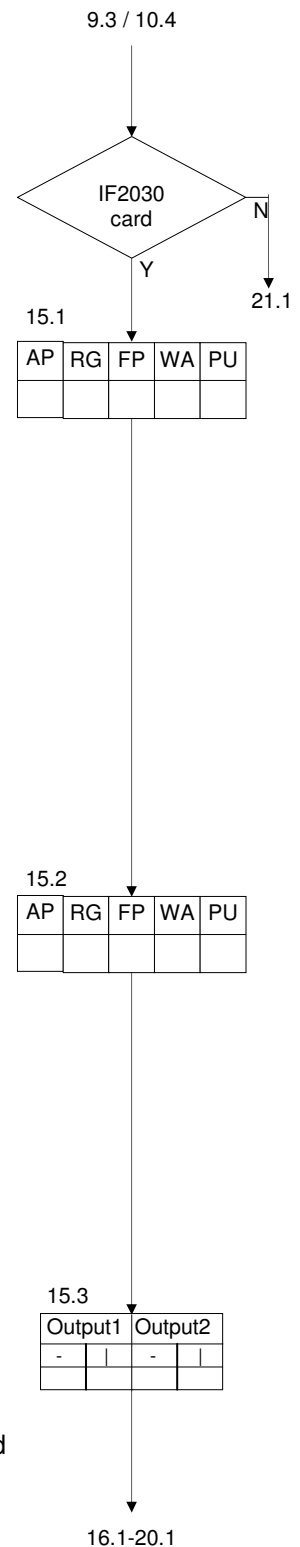



16. 'Additional program' output

An additional relay can be controlled during the regeneration of a filter. This can be used to initiate washing programs or switch on supply or dosage pumps. In the following steps the switch on point is set before, during or after regeneration, and the time the relay stays switched on is determined.

In each case, the switch on point is the start of a new regeneration phase. But if phase '0' is entered as the switch on point the additional program runs before the actual regeneration program.

Or if the letter 'E' (for end) is selected as the switch on point, the additional program is running after the end of the regeneration.

Switch on point

Step no.:	16.1
Start phase	<u>2</u>

Switch on time

Step no.:	16.2
Time 'On'	<u>20</u> m

Values from 1 to 999 minutes can be entered for the switch on time of the additional program.

Switchover of service valve

Step no.:	16.3
SV changeover	<u>Y/N</u>

If phase '0' was entered as switch on point at program step 16.1, it has to be decided whether the open service valve of the filter in service is to be shut immediately when the additional program is switched on (Y/N) or it is only closed on completion of the additional program time (Y/N).

In the case of two filter systems in alternate service, it is determined whether to switch immediately to the standby filter (Y/N) or if this only happens on completion of the additional program time (Y/N).

NOTE: When 'SV changeoverY/N' the programmed setting 'Stop in service'(program step 4.1 –SP) is activated.

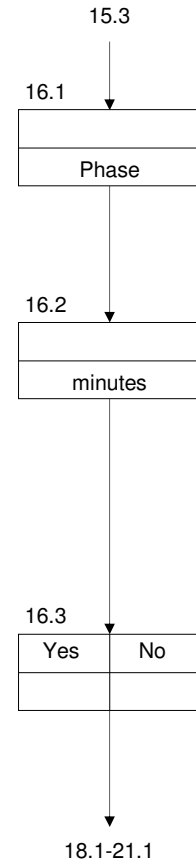

17. 'Regeneration' output

If the 'regeneration' function is selected, the relevant additional relay is activated for the full time of the regeneration.

NOTE: No program data are entered for this function.



18. 'Flow pulse' output

Step no. : 18.1
imp . succes 1001

If the flow pulse function is selected, the relevant additional relay is activated after a set amount of water. Values from 1 to 9999 litres can be entered. The next program step determines how long the relay remains active for each pulse.

This function can be used to control a dosage pump, a dosage controller or as a flow monitor contact.

Water meter pulses following each other in rapid sequence are recorded and if necessary passed on at an interval of 0,2 seconds after each other.

Step no. : 18.2
i .duration 1.0s

Values between 0,1 and 999,9 seconds can be entered for the pulse duration.

19. 'Warning' output

Step no. : 19.1
M|Wa-P-Ce-S-C-H-

During the service and regeneration of the system of the system various signals occur which can be switched to additional relay 1 or 2.

(' | ' = selected, ' - ' = not selected).

If more than one signal is selected, the relevant relay functions as a combined warning relay.

- M = Minimum regeneration distance*
Note: Only where 'minimum regeneration distance' has been set.
- Wa = Waiting for regeneration to resume*
Note: Only where 'delayed regeneration' has been set.
- P = Power loss*
- Ce = Capacity exceeded*
Note: Only in two filters systems with water meter.
- S = Stop during service*
Note: Only where an input with Stop function is selected.
- C = Chemicals shortage*
Note: Only where an input for monitoring the chemicals is selected.
- H = Stop during regeneration*
Note: Only where an input with Stop function is selected.

Where signals cannot be selected in the LCD display, the appropriate program step(s) must be altered; e.g. input functions with 'water meter', 'minimum regeneration distance' etc.

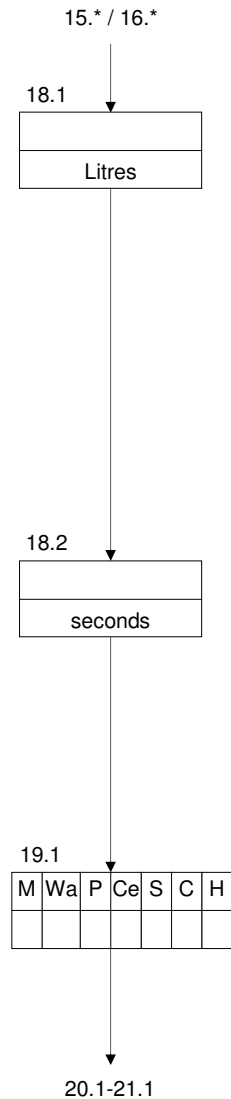

20. 'Flushing' output

The 'flushing' function can be used to control a volume proportionate flushing or clarification. The flushing time determines how long the flushing valve remains open during a flushing process. The flushing interval sets the amount of flow after which the flushing valve is opened.

Step no. : 20.1
Flushtime 20s

Times from 1 to 255 seconds can be entered.

Step no. : 20.2
Flush int. 500l

Intervals from 1 to 65.000 litres can be entered.

21. Buzzer

Step no. : 21.1
M|_Wa-P-Ce-S-C-H-

During the service and regeneration of the system of the system various signals occur which can be switched to the built in buzzer. ('|' = selected, '-' = not selected).

- M = Minimum regeneration distance
Note: Only where 'minimum regeneration distance' has been set.
- Wa = Waiting for regeneration to resume
Note: Only where 'delayed regeneration' has been set.
- P = Power loss
- Ce = Capacity exceeded
Note: Only in two filters systems with water meter.
- S = Stop during service
Note: Only where an input with Stop function is selected.
- C = Chemicals shortage
Note: Only where an input for monitoring the chemicals is selected.
- H = Stop during regeneration
Note: Only where an input with Stop function is selected.

Where signals cannot be selected in the LCD display, the appropriate program step(s) must be altered; e.g. input functions with 'water meter', 'minimum regeneration distance' etc.

22. Programming mode

Step no. : 22.1
Program mode 0

To protect the controller against unauthorized or accidental alterations to the basic settings which have been programmed in, various levels of access to the programming can be set:

- Mode 0** : No restrictions on programming
- Mode 1** : Only the following times and settings can be changed :
 1.1-1.7, 4.1, 5.1, 6.1-6.10, 7.1-7.2, 8.1-8.4, 16.2
- Mode 2** : No changes can be made to the basic programming

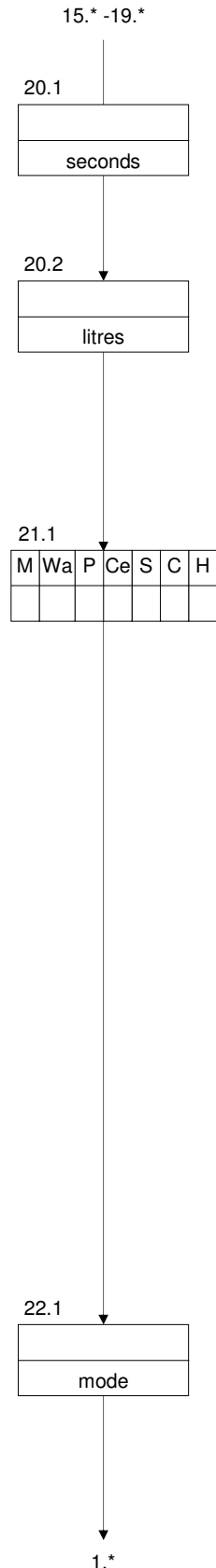

Examples of systems

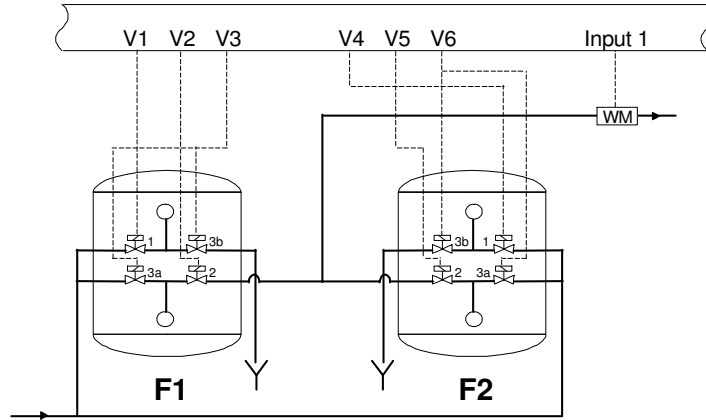

Double sand filter with individual valves.

Typical electrical wiring diagrams

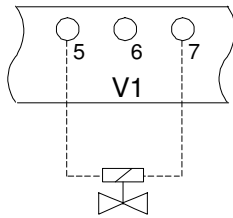

Example 1

Connecting a magnetic valve opening under voltage to :

- Connector V1 : terminals 5 and 7
- Connector V2 : terminals 8 and 10
- Connector V3 : terminals 11 and 12
- Connector V4 : terminals 13 and 15
- Connector V5 : terminals 16 and 18
- Connector V6 : terminals 19 and 20

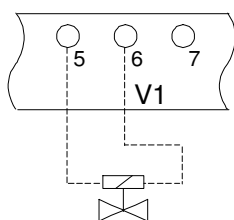

Example 2

Connecting a magnetic valve closing under voltage to :

- Connector V1 : terminals 5 and 6
- Connector V2 : terminals 8 and 9
- Connector V4 : terminals 13 and 14
- Connector V5 : terminals 16 and 17

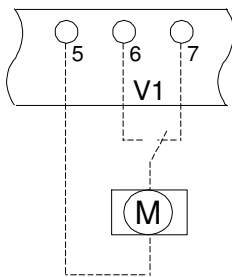

Example 3

Connecting a servo motor to :

- Connector V1 : terminals 5, 6 and 7
- Connector V2 : terminals 8, 9 and 10
- Connector V4 : terminals 13, 14 and 15
- Connector V5 : terminals 16, 17 and 18

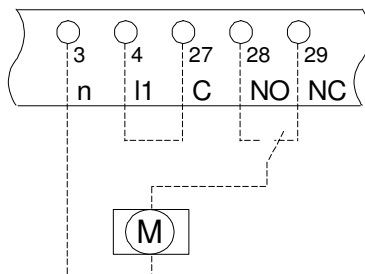

Example 4

Connecting a servo motor to the potential free relay output :

- Connector OUT1 : terminals 3, 28 and 29
 bridge from 4 to 27
- Connector OUT2 : terminals 3, 31 and 32
 bridge from 4 to 30

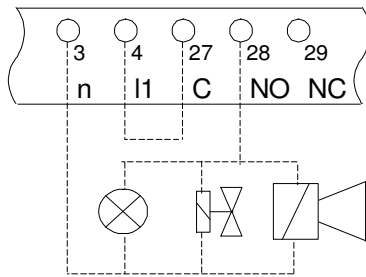

Connection to a signal lamp, klaxon or magnetic valve active when voltage applied on potential free relay output :

- Connector OUT1 : terminals 3 and 28
 bridge from 4 to 27
- Connector OUT2 : terminals 3 and 31
 bridge from 4 to 30

Example 5

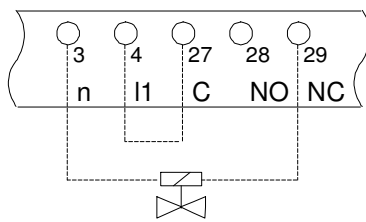

Connection to a magnetic valve active when voltage not applied on potential free relay output :

- Connector OUT1 : terminals 3 and 29
 bridge from 4 to 27
- Connector OUT2 : terminals 3 and 32
 bridge from 4 to 30

Example 6

Connection terminals ES2030 SV

Only earth terminal 33
no control lamp in the main switch

ES2030 SV - 24 V :

Only ES2030 SV 115/24 V and 230/24 V

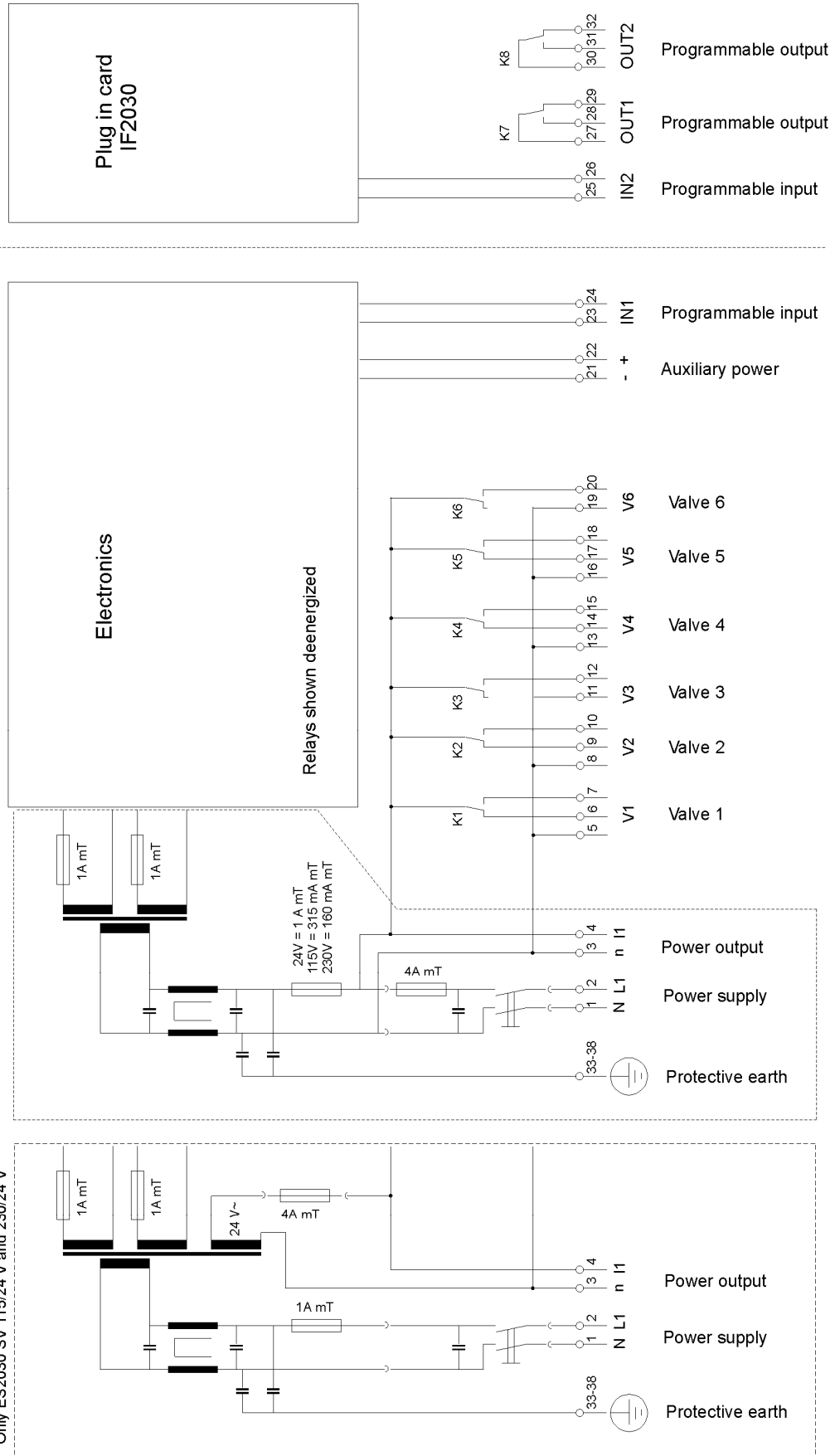



Notes on installation and initial use

General

Installation and commissioning of the control system may only be carried out by trained specialists who are familiar with these operating instructions and the applicable regulations on safe working practices and accident prevention. The instructions given in this manual must always be observed and followed.

To guarantee functional operation and safety, the instructions in this manual must be followed. The manufacturer accepts no liability for damage resulting from failure to follow the instructions.

Assembly

- Do not install under damp pipes. Fit shielding if necessary.
- Install device at eye level and easily accessible to the user.

Connection

- Before carrying out connection work, always ensure the control unit is first disconnected from the power supply. Make sure that the power supply remains disconnected during connection work.
- Make electrical connections. Observe local regulations.
Connect supply voltage and ground to the terminals shown in the wiring diagram.
- Make sure that the ground connection is faultless.
- If possible, keep all extra low voltage cabling (digital inputs, measurements) separate from the power supply cable.
- It is not permitted to connect the potential-free relays with a combination of 230 VAC and extra low voltage.
- Some external relays, magnetic switches, solenoid valves, etc. can cause unwanted interference pulses when switched off.
For this reason, it is recommended that the components mentioned should be equipped with a so-called RC network in advance.
Ask the supplier of the mentioned components for the correct type of RC network.

Maintenance

The control system does not contain any user-serviceable parts. Unauthorised modifications and/or repairs to the control unit will void all warranty claims and the manufacturer's liability.

Commissioning

- Keep front lid closed at all times
- The control system may only be switched on if it is completely closed and all connections have been made correctly.



Technical data



Electrical supply :	24V	± 10%	50-60 Hz	fuse 4A mT
	115V	± 10%	50-60 Hz	fuse 4A mT
	230V	± 10%	50-60 Hz	fuse 4A mT
	115/24V	± 10%	50-60 Hz	fuse 4A mT
	230/24V	± 10%	50-60 Hz	fuse 4A mT
Power consumption :	11VA			
Powered outputs:	24V, 115V, 230V			: Total continuous current 4 A
	115/24V, 230/24V			: Total continuous current 2 A
Dry contact :	Max load capacity 250V, 4A			
Inputs :	Load capacity 9V, 8 mA			
Protection class :	IP65			
Ambient temperature:	0 - 40° C			
Weight :	Approx. 1,3 kg (24V, 115V, 230V)			
	Approx. 1,7 kg (115/24V, 230/24V)			
Dimensions :	W x H x D = 211 x 185 x 95 mm			
Particulars :	Device is protected against zero voltage Reset current time after a prolonged power loss			



Declaration of conformity

Declaration of conformity of the product with the essential requirement of the EMC directive 89 / 336 / EEC.

Product description

Product name : Controller for water softening installation
Product type : ES2030SV
Manufacturer : EWS Equipment for Water treatment Systems International B.V.
Australiëlaan 12
NL-5232 BB 's-Hertogenbosch
The Netherlands

Product environment

This product is intended for use in residential en light industrial environments.

Emission standard : EN 61000-6-3, EN55022
Immunity standard : EN 61000-6-1
Low voltage directive : 2006/95/EG

Report

Report number : EWS / EMC / ES2030SI

This declaration was issued by :

Date : 11 – 03 - 2020

Name : V. Naeber

Signature :



FIVE-YEAR CONTROLLER LIMITED WARRANTY

LIMITED WARRANTY

EWS International (hereafter EWS) warrants her products free from defects in material and workmanship under the following terms.

In this warranty, "Products" shall be taken to mean all devices that are supplied pursuant to the contract with exception of software.

VALIDITY OF THE WARRANTY

Labour and parts are warranted for five years from the date of the first customer purchase. This warranty is only valid for the first purchase customer.

Notwithstanding the warranty period of five years as mentioned above - while upholding the remaining provisions – a warranty period of three months applies to the supply of software.

COVER OF THE WARRANTY

Subject to the exceptions as laid down below, this warranty covers all defects in material or workmanship in the EWS products. The following are not covered by the warranty:

- 1) Any product or part not manufactured nor distributed by EWS. EWS will pass on warranty given by the actual manufacturer of products or parts that EWS uses in the product.
- 2) Any product, on which the serial number has been defaced, modified or removed.
- 3) Damage, deterioration or malfunction resulting from:
 - a) Accident, misuse, neglect, fire, water, lightning or other acts of nature.
 - b) Product modification or failure to follow instructions supplied by the products.
 - c) Repair or attempted repair by anyone not authorized by EWS.
 - d) Any shipment of the product (claims must be presented to the carrier)
 - e) Removal or installation of the product
 - f) Any other cause, which does not relate to a product defect.
 - g) Cartons, equipment enclosures, cables or accessories uses in conjunction with the product.

FINANCIAL CONSEQUENTES

EWS will only pay for labour and material expenses for covered items, proceed from repairs and updates done by EWS at the EWS location. EWS will not pay for the following:

- 1) Removal or installations charges at customers and/or end user location.
- 2) Costs for initial technical adjustments (set-up), including adjustment of user controls or programming.
- 3) Shipping charges proceed from returning goods by the customer. (Shipping charges for returning goods to the customer are for the account of EWS).

All the costs which exceed the obligations of EWS under this Warranty, such as, but not limited to, travel and accommodation costs and costs for assembly and dismantling are for the account and risk of the customer.

WARRANTY SERVICE

In order to retain the right to have a defect remedied under this warranty, the customer is obliged to:

- 1) Submit complaints about immediately obvious errors related to the products delivered, in writing within eight days of the delivery of the products and submit complaints about shortcomings relating to the products delivered, which are not visible, within eight days of their being discovered.
- 2) Return defected products for account and risk of the customer. Costs for this shipment will not be reimbursed by EWS. The products may only be returned following express, written permission from EWS. Returning the products does not affect the obligation to pay the invoiced amounts.



- 3) Present the original dated invoice (or a copy) as proof of warranty coverage, which must be included in any [of the] return shipment of the product. Please include also in any mailing a contact name, company, address and a description of the problem(s).

LIMITATION OF IMPLIED WARRANTIES

Except where such disclaimers and exclusions are specifically prohibited by applicable law, the foregoing sets forth the only warranty applicable to the product, and such warranty is given expressly and in lieu of all other warranties, express or implied, or merchantability and fitness for a particular purpose and all such implied warranties which exceed or differ from the warranty set forth herein are hereby disclaimed by EWS.

EXCLUSION OF DAMAGES

EWS' liability for any defective products is limited to the repair or replacement of the product at our option. Except where such limitations and exclusions are specifically prohibited by applicable law EWS shall not be liable for:

- 1) Damage to other property caused by defects in the EWS product, damages based upon inconvenience, loss of use of the product, loss of time, commercial loss or:
- 2) Any damages, whether incidental, [consequential or otherwise] special, indirect or consequential damages, injury to persons or property, or any other loss.

Under no circumstances whatsoever shall EWS be obliged to provide compensation beyond the direct damage incurred by customer up to an amount not exceeding the payment receivable from the insurer of EWS in connection with the damage.

APPLICABLE LAW AND DISPUTES

- 1) Dutch law shall govern all offers made by EWS and all agreements concluded between EWS and customer. This warranty explicitly excludes application of the Vienna Sales Convention (CISG).
- 2) All disputes which may arise between the parties shall be dealt with exclusively by the competent court of law in the Netherlands under whose jurisdiction EWS falls. However, EWS reserves the right to submit any disputes to the competent court in the customer's location.