FCS 3000

**Controller for ion exchangers or filter installations
with CLACK control valves.**



Instruction manual

Software version 1.04

Contents

1. Function description	1
1.1. List of abbreviations	1
2. Installation examples	2
2.1. Overview connections	3
3. Illustration front	4
4. Operating and regeneration messages	5
4.1. Display LED's	5
4.2. Display LCD	5
4.2.1. During service	5
4.2.2. During the wait for regeneration	6
4.2.3. During the regeneration of a filter	6
4.2.4. During refresh	7
4.2.5. Message	7
5. General operation	8
5.1. Scrolling	8
5.2. Changing of numeric values	8
6. Manual control while the installation is in service	9
6.1. Reset alarm	9
6.2. Manual regeneration start	10
6.3. Regeneration without water counter reset	10
6.4. Regeneration of Filter 1 only	10
6.5. Regeneration of Filter 2 only	10
6.6. Regeneration of the standby filter	10
6.7. Filter change without program start	11
6.8. Manual start of complete regeneration	11
6.9. Manual start of refresh	11
7. Manual Control during regeneration	12
7.1. Reset alarm	12
7.2. Stop Regeneration	12
7.3. Accelerated regeneration	12
7.4. In service	13
7.5. Start regeneration manually in case of an alarm message	13
8. Requesting information	14
8.1. Software version	14
8.2. Service number	14
8.3. Inputs	14
8.4. Outputs	15
8.5. Exchange capacity	15
8.6. History	16
8.6.1. Regeneration information	16
8.6.2. Other information	17
8.7. Maintenance	18
8.8. Chlorine production	18
9. Changing the language setting	19
9.1. Changing the language back to the factory setting	19
10. Setting the hardness	20
11. Changing the clock	22
11.1. Time	22

11.2. Date	22
12. Programming	23
12.1. Hardware	23
12.1.1. Water meter.....	23
12.1.1.1. Turbo water meter.....	24
12.1.1.2. Impulse water meter	24
12.1.1.3. None.....	24
12.1.2. Inputs.....	25
12.1.2.1. Chemicals tank.....	25
12.1.2.2. Waiting during regeneration	26
12.1.2.3. Regeneration start	26
12.1.2.4. Level switch.....	27
12.1.2.5. Water meter	27
12.1.2.6. No function	27
12.1.3. Outputs.....	28
12.1.3.1. Additional program.....	28
12.1.3.2. Regeneration course.....	29
12.1.3.3. Flow-pulse	29
12.1.3.4. Feed pump	29
12.1.3.5. Alarm.....	29
12.1.3.6. No function	30
12.1.4. Filters.....	30
12.1.5. Clack valve	31
12.1.6. Chlorine production	31
12.2. Installation type	32
12.3. Regeneration settings	34
12.3.1. Switch steps	34
12.3.2. Regeneration process	34
12.3.3. Start conditions.....	36
12.3.3.1. Water meter (impulse/turbo)	36
12.3.3.2. Precontact	36
12.3.3.3. Interval time.....	37
12.3.3.4. Time start	37
12.3.4. Stop conditions.....	38
12.3.4.1. Delayed regeneration.....	38
12.3.4.2. Minimum regeneration distance.....	39
12.3.4.3. Capacity exceeded	39
12.3.4.4. Input WA	40
12.3.4.5. Input CT	40
12.3.5. Proportional Brine	40
12.4. Alarms	41
12.4.1. Power supply failure.....	41
12.4.2. Buzzer	41
12.4.3. Alarm 1	42
12.4.4. Alarm 2	42
13. Service.....	43
13.1. Telephone number	43
13.2. Change code	43
13.3. Maintenance interval	43
13.3.1. Capacity	44
13.3.2. Time	44
13.3.3. Regeneration.....	44
13.3.4. Pre-notification	44
13.4. Testing.....	45
13.4.1. Motor test	45
13.4.2. LED check	45
13.4.3. Output check	45
13.4.4. Input check.....	45
13.4.5. Buzzer check.....	45
13.4.6. 3-way valve	45

13.4.7. Chlorine (current) output	45
13.5. Resets	46
13.5.1. Water meter.....	46
13.5.2. Motor 1	46
13.5.3. Motor 2	46
13.5.4. Programming.....	46
13.5.5. Maintenance interval	46
13.5.6. Complete reset.....	46
14. Possible error messages	47
14.1. Installation capacity exceeded	47
14.2. Power supply failure	47
14.3. Chemicals low	48
14.4. Delayed regeneration	48
14.5. Waiting during regeneration	48
14.6. Minimum regeneration distance	48
14.7. Precontact	49
14.8. Maintenance interval	49
14.9. Motor 1	50
14.10. Motor 2	50
14.11. Motor 1 time exceeded.....	50
14.12. Motor 2 time exceeded.....	51
14.13. Chlorine production	51
15. Frequently asked questions	52
16. Overview menu	53
17. Opening of housing.....	54
18. Connection diagram FCS3000	55
18.1. Glossary	56
19. Electrical connection examples	57
20. Installation and start-up regulations	58
21. Maintenance	59
22. Spare components	60
22.1. Connecting cable.....	60
23. Technical data	61
23.1. Housing dimensions	61
24. Declaration of conformity	62
APPLICABLE LAW AND DISPUTES.....	64



1. Function description

The FCS3000 is used for the automatic control and monitoring of single and duplex filter installations that are equipped with CLACK control valves.

The flexibly programmable software makes this control suitable for a large number of different applications in the field of water treatment. With this control, ion exchangers and filter installations can be operated in combination with one or two CLACK control valves.

ATTENTION: In this instruction manual, the rinsing process of a filter installation (e.g. iron removal) is also indicated as 'Regeneration' for convenience sake, as is usual in the case of an ion exchanger.

Overview functionality

- Menu driven operation and programming of the controls by means of an LCD display (4 lines with 20 characters).
- Language selection (Dutch, English, German and French).
- Universally adaptable for the remote controlling of CLACK control valves.
- Flexibly programmable for specific user requirements.
- Programmable regeneration process via phase option (fill chemicals tank, rewind, upward and downward conducting through and rinsing of chemicals) and the duration of each phase.
- Suitable for single and duplex filter installations.
- Programmable capacity of 500 to 65000 m³.⁹ hardness , or of 500 to 65000 m³.
- Freely programmable service telephone number.
- Regeneration start using interval, volume, external contact, real-time clock and/or Manual Control.
- Delayed regeneration.
- Extensive information display.
- Additional functions for service personnel. Such as high-speed regeneration, filter change without regeneration, regeneration of the standby filter, regeneration without counter reset, instant stopping of the regeneration.
- 2 power conducting outputs for the service valves.
- Connections for 2 turbo water meters.
- 2 programmable inputs: Impulse water meter (instead of turbo), interruption of regeneration, start regeneration, chemicals tank empty, level switches.
- 2 programmable, potential-free outputs: additional program, regeneration, alarm.
- Protection of the program information in case of voltage interruption, the program information is stored without using a battery.
- Manufactured in accordance with EMC guidelines.
- Available for construction, build-in and *panel construction*.
- Available for supply voltages (input/output): 24/24V, 115/115V, 230/230V, 115/24V, 230/24V of 240V/24V.
- Optional circuit board with :
 - 0-500mA output for chlorine production
 - Control of 3-way valve from Clack
- Proportional brine
- Refresh of standby filter during alternating service of 2 filters

1.1. List of abbreviations

Below is a list of frequently used abbreviations.

SV1	Service valve 1	FP2	Output feed pump 2
SV2	Service valve 2	CT	Input chemicals tank
OUT1	Output 1	WA	Input wait
OUT2	Output 2	RS1	Input Regeneration start 1
IN1	Input 1	RS2	Input Regeneration start 2
IN2	Input 2	LH	Input high level switch
AP1	Output additional program 1	LL	Input low level switch
AP2	Output additional program 1	WM1	Input pulse water meter 1
RE1	Output regeneration 1	WM2	Input pulse water meter 2
RE2	Output regeneration 2	NC	Contact normally closed
FP1	Output feed pump 1	NO	Contact normally opened

2. Installation examples

Here are a few installation examples.

Example 1

The example depicted here has been programmed as a single filter with a protection of the chemicals tank and an impulse water meter.

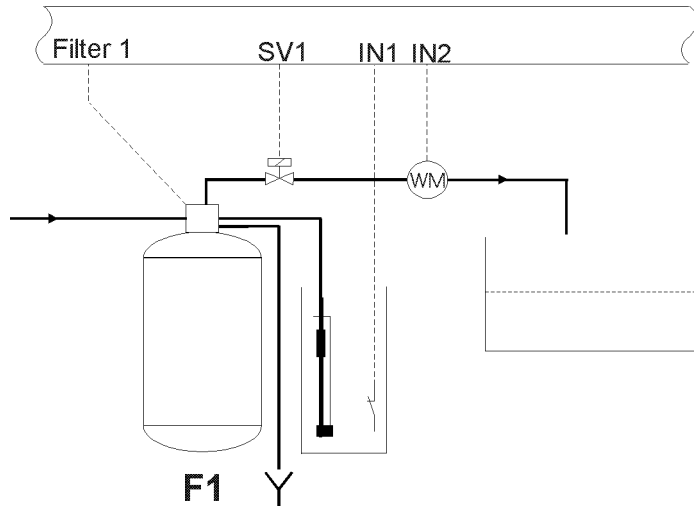

Single installation

Example 2

The example depicted here has a high-level switch and makes use of two turbo water meters. The installation can be programmed as follows:

- Change service standard
- Change service with regeneration for service
- Parallel service

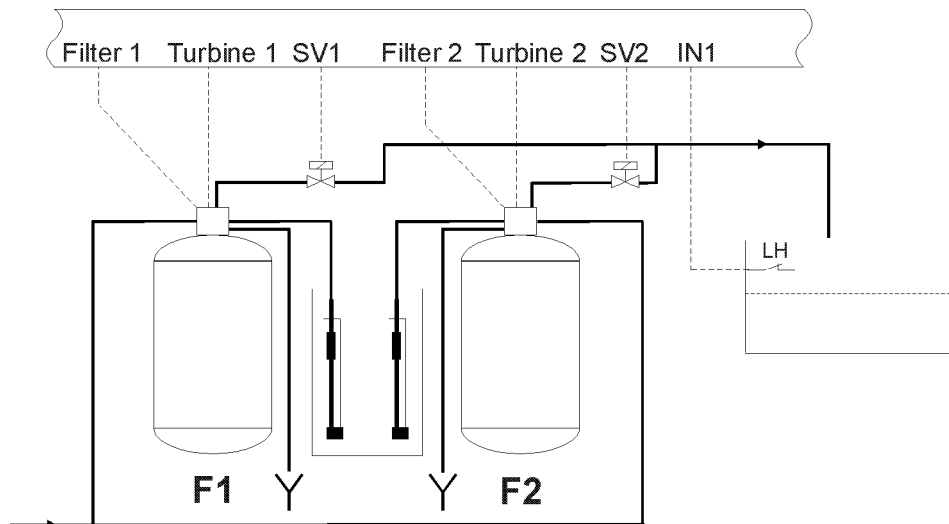

Duplex installation

Example 3

The example depicted here has a high-level switch and makes use of the two turbo water meters. The installation has been programmed as in series service.

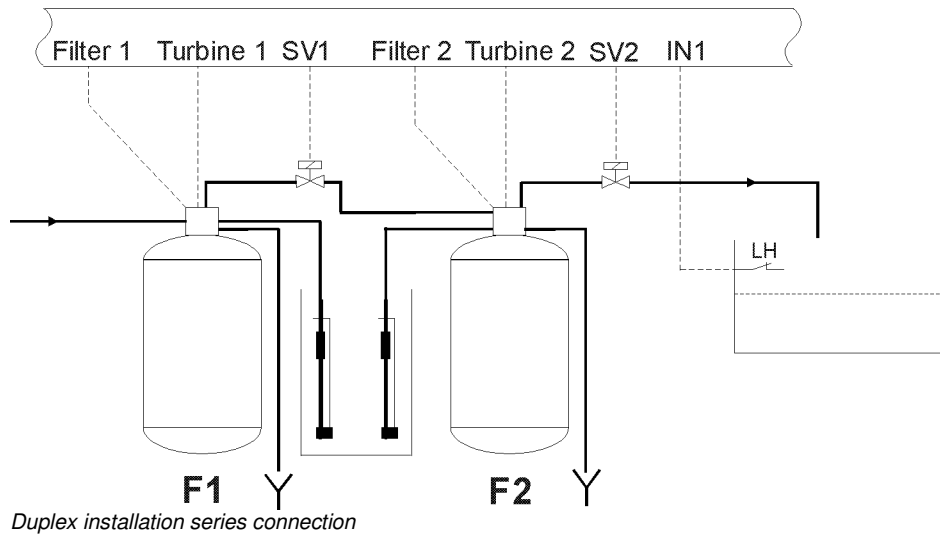

2.1. Overview connections

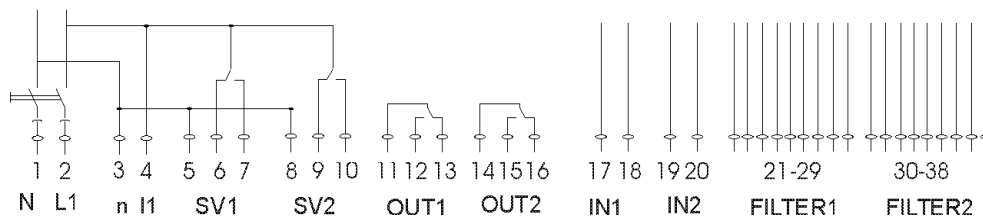

2x output for magnet valves or servo motors (valve 1 and valve 2)

2x output, programmable for the functions: Additional program, Regeneration progress, message (OUT1 en OUT2).

2x signal input, programmable for the functions: water meter, high level switch, low level switch, start regeneration or lack of chemicals (IN1 in IN2).

2 x connections for filter 1 and filter 2, CLACK control valves.

For a more detailed drawing with description of provisions for connection, see: §18 "Connection diagram FCS3000", page 55.

3. Illustration front

Wall construction, built-in and panel construction

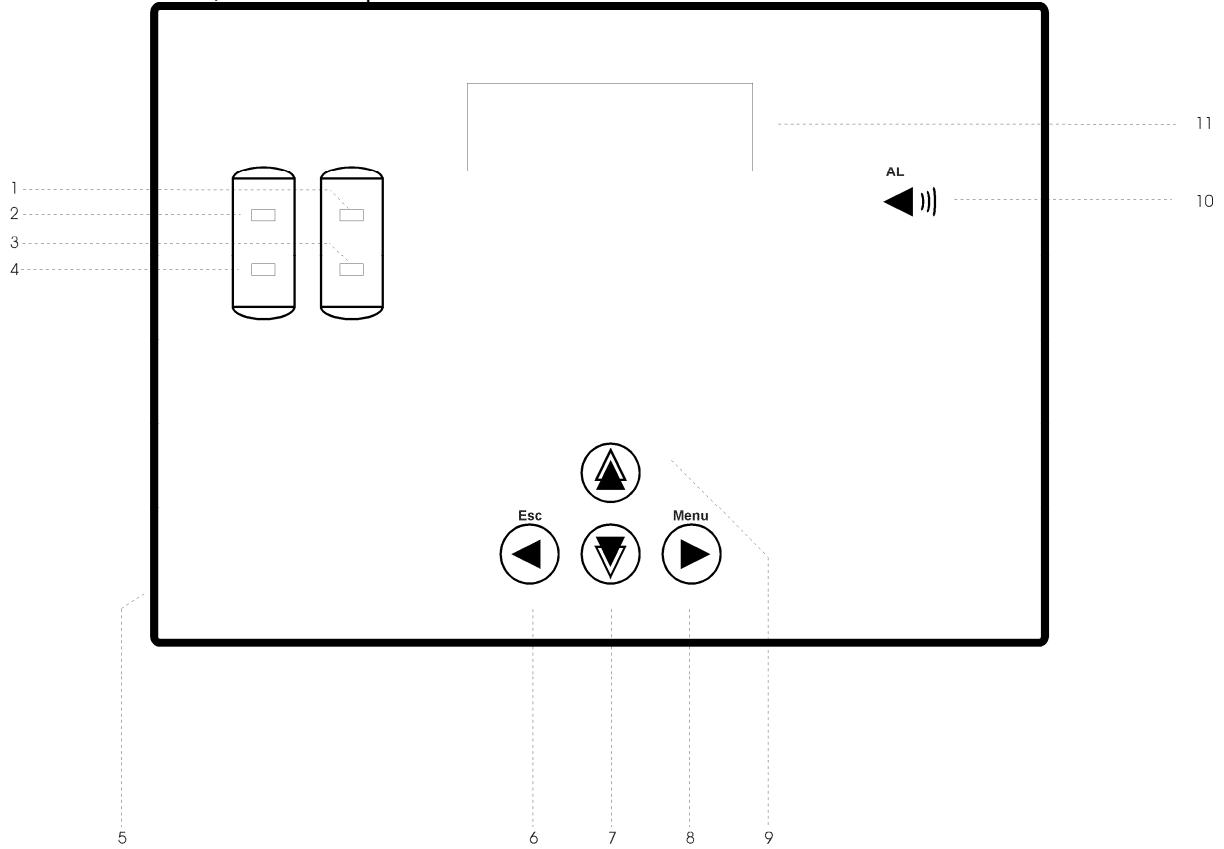

- | | |
|------------------------------|-----------------|
| 1. Service LED filter 2 | 7. Down |
| 2. Service LED filter 1 | 8. Menu |
| 3. Regeneration LED filter 2 | 9. Up |
| 4. Regeneration LED filter 1 | 10. Alarm LED |
| 5. Main switch | 11. LCD-display |
| 6. Esc | |

4. Operating and regeneration messages

4.1. Display LED's

Coloured check lights indicate the most important operational positions:

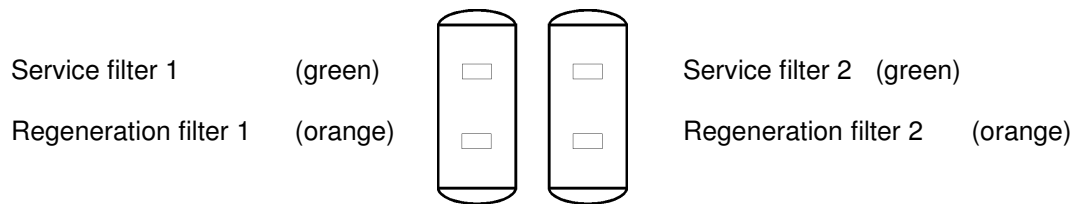

Operating position

The green LED of filter 1 or filter 2 is continuously lit. The relevant filter is in service, which means that the service valve is open.

Standby

The green LED of filter 1 or filter 2 flashes. In this situation the service valve of the relevant filter is closed, because the following situation is active: input level switch.

Regeneration

The orange LED of filter 1 or filter 2 is continuously lit. The relevant filter is busy with the regeneration process.

Waiting before regeneration

The orange LED of filter 1 or filter 2 is flashing. The relevant filter cannot start the regeneration or the regeneration has been interrupted, because one or more of the following situations is/are active:

- delayed regeneration
- minimal regeneration distance
- input on hold
- input lack of chemicals
- capacity exceeded (the other filter is already regenerating)

4.2. Display LCD

In the next sections will be described what the display can show during the various positions of the filter or during an alarm message. The LCD display will alternately show the following information: status filter 1 → status filter 2 → alarm message → status filter1 → etc. The screen "alarm message" will only be displayed if an alarm situation is active.

4.2.1. During service

First LCD line

On the first line of the LCD display, the current status of the installation is displayed, e.g. "Filter 1 Service", "Filter 1 Regeneration", "Filter 1 Standby", "Filter 1 Refresh", "Filter 2 service", "Filter 2 Regeneration", "Filter 2 Standby" or "Filter 2 Refresh".

```
Filter 1 Service
100.00m3
```

```
Sa.12:00 01/01/2005
```

Second LCD line

The following information appears on the second line of the LCD display during service; the remaining amount of water to be produced up to the next regeneration if a water meter has been connected and programmed. See §12.1.1 "Water meter", page 23.

Third LCD line

The following information appears on the third line of the LCD display during service.

The remaining interval time (hours: minutes) until the next regeneration, provided that "Interval time" has been programmed under §12.3.3.3 "Interval time", page 37.

```
Filter 1 Service
 100.00m3
Interval 1:15h
Sa.12:00 01/01/2005
```

Or the time of the next generation, provided that a time has been programmed under §12.3.3.4 "Time start", page 37.

```
Filter 1 Service
 100.00m3
Timestart Mo.12:00a
Sa.12:00a 01/01/2005
```

Fourth LCD line

On the fourth line, the current time and date are displayed together.

4.2.2. During the wait for regeneration**First LCD line**

If under §12.3.4 "Stop conditionss", page 38, the delayed regeneration has been programmed. And if a regeneration is desired but not permitted because the delayed regeneration is not active. In that case, the message "Wait for regeneration" will appear in the display.

```
Filter 1 Wait for
Regen. Tu.06:00

Sa.12:00 01/01/2005
```

Third LCD line

The time at which a next regeneration is permitted again will be displayed on the third line.

Fourth LCD line

The current day and time are displayed together on the fourth line.

4.2.3. During the regeneration of a filter**First LCD line**

The current position of the filter. E.g. Filter one is now in regeneration.

```
Filter1 Regeneration
Backwash 1/ 5m

Sa.12:00 01/01/2005
```

Second LCD line

During the regeneration, the current phase and the remaining time are displayed on the second line of the LCD display.

or:

"Addit. prog for", this is the additional program for regeneration. This means that before the regeneration is executed, an additional program is implemented during which the relevant outputs are energized. (See §12.1.3.1 "Additional program", page 28 for more information)

Third LCD line

During a regeneration, the remaining time of the additional program and/or the remaining time of the chlor production that is implemented will be displayed on the third line of the LCD display.

```
Filter1 Regeneration
Add. program before
AP2:6m Desinf:20m
Sa.12:00 01/01/2005
```

Fourth line

The current date and time are displayed together on the fourth line.

4.2.4. During refresh

First LCD line

On the first line of the LCD display, the current status of the installation is displayed.

```
Filter 1 Service
100.00m3
```

Second LCD line

The following information appears on the second line of the LCD display during service; the remaining amount of water to be produced up to the next regeneration if a water meter has been connected and programmed. See §12.1.1 "Water meter", page 23.

```
Sa.12:00 01/01/2005
```

Third LCD line

The following information appears on the third line of the LCD display during service.

The remaining interval time (hours: minutes) until the next regeneration, provided that "Interval time" has been programmed under §12.3.3.3 "Interval time", page 37.

```
Filter 1 Service
100.00m3
Interval 1:15h
Sa.12:00 01/01/2005
```

Or the time of the next generation, provided that a time has been programmed under §12.3.3.4 "Time start", page 37.

Fourth LCD line

On the fourth line, the current time and date are displayed together.

```
Filter 1 Service
100.00m3
Timestart Mo.12:00a
Sa.12:00a 01/01/2005
```

4.2.5. Message

As soon as an alarm occurs, this will always be shown in "Message" screen of the LCD display. During the display of the messages, the number of pages that the messages contain can be read from the first line of the LCD display. In this case 4 screens and the current screen is screen 1.

```
Message 1/4
Delayed regeneration
```

For a more detailed description of the various messages see chapter §14 "Possible error messages", page 47 .

5. General operation

The operation and programming of these controls takes place by means of four keys at the front of the control panel. Below, the general functions of the 4 differing control keys are described.

- Menu** Function:
- 
- Jump to the main menu or sub menu.
 - Confirm a change.
 - Select an option.

- Esc** Function:
- 
- Leave the main menu or sub menu.
 - Do not store a changed value.

- Function:
- 
- Move cursor up.
 - Raise the value.

- Function:
- 
- Move cursor down.
 - Lower the value.

5.1. Scrolling

The “>” sign is the cursor and is positioned on the current selection.

As soon as one of the following signs “▲” and/or “▼” on the right side of the display, this means that there are more menu items. Scrolling in the menu can be done by using the up or down key, in order to show or select the other items/options.

Main menu	
>Information	▲
Clock	
Hardness	▼

5.2. Changing of numeric values.

All numeric values can be raised using the  “Up” key.

ATTENTION: When the maximum value is reached, there will be an automatic jump back to the minimum value.

Lowering is done by using the  “Down” key.

ATTENTION: When the minimum value is reached, there will be an automatic jump to the maximum value.

The changed value can be stored using the  “Menu” key or can be cancelled by using the

 “Esc” key.

A broad outline of the menu can be found under §16 “Overview menu”, page 53.

6. Manual control while the installation is in service.

THESE FUNCTIONS SHOULD EXCLUSIVELY BE CALLED UP BY A WATER TREATMENT EXPERT, INCORRECT USE MAY LEAD TO UNDESIRE MALFUNCTIONS.

Below, all manual options that are possible when none of the filters are regenerating are described.

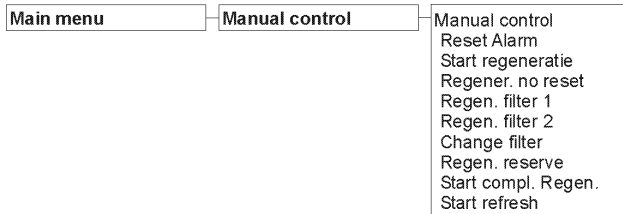

While selecting an action, a confirmation will be subsequently asked for so as to ultimately carry out the action. The action can still be cancelled by using the “Esc” key, whereas the “Menu” key is used to actually carry out the action.

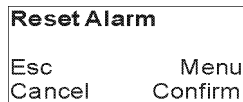

For example: If the action “Reset Alarm” is selected, it is possible to cancel the action by using “Esc”, or to actually carry out the action, a reset of the alarm, “Menu” should be selected.

6.1. Reset alarm

In an alarm situation, there will always be a message in the LCD display. Depending on the programming (See §12.4 “Alarm”, page 41) the built-in buzzer and/or one or more alarm outputs will be activated.

By means of the menu option **Reset Alarm**, the buzzer, the alarm output or message can be switched off. The flow diagram below shows which action is required when **Reset Alarm** is carried out.

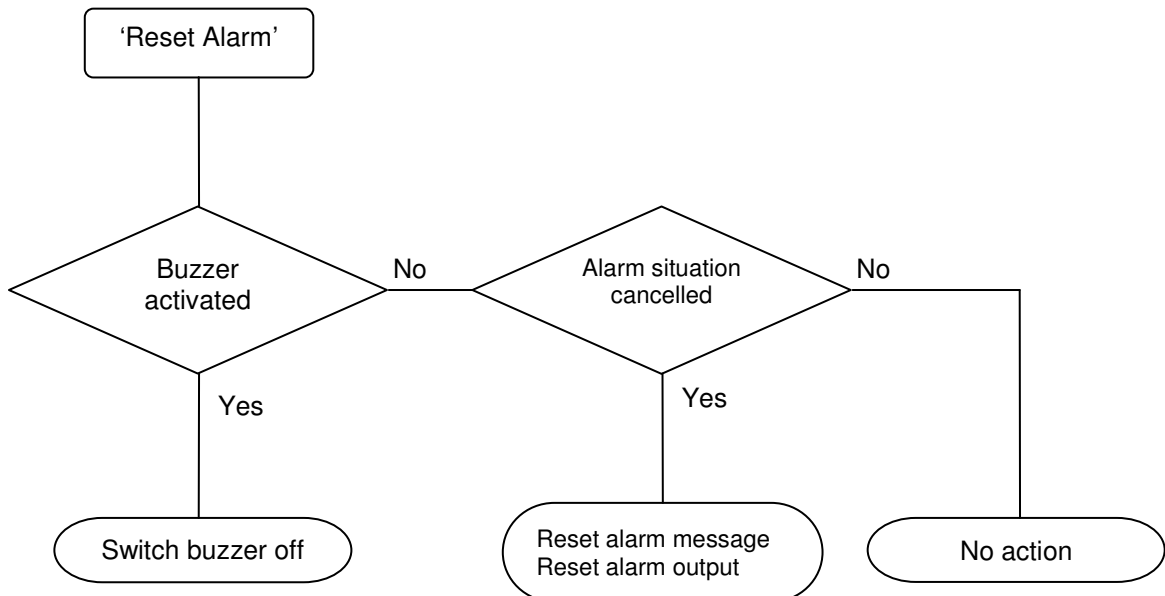



6.2. Manual regeneration start

At any time, a regeneration can be started manually, provided that none of the filters is busy with a regeneration. Select **Start Regeneration** in the **Manual control** menu to start a manual regeneration. As soon as a regeneration has started, the counter of the interval start will be reset, if programmed in §12.3.3 “Start conditions”, page 36, **Interval Time**.

Also, the counter will be set again for the minimum regeneration distance if programmed in §12.3.4 “Stop conditions”, page 38, **Minimum regeneration distance**.

Alternate service

In the case of installations which have exchange connections, the standby filter is put into service.

Delayed regeneration

If under §12.3.4 “Stop conditionss”, page 38, the **Delayed regeneration** has been programmed, then a rotation will not be immediately started. To be able to nevertheless start a regeneration, also §7.5 “Start regeneration manually in case of an alarm message” page 13.

6.3. Regeneration without water counter reset

ATTENTION: This option is only possible using single filter and exchange connections.

It may be necessary, due to maintenance purposes, to check the regeneration process without resetting the water meter values and without a renewed calculation of the filter capacity.

Do not select reset in the **Manual Control – Regeneration** menu to carry out a regeneration without a water meter reset.

In the case of duplex installations, the standby filter is regenerated and the displayed capacity values remain unchanged. If the filter that is in service must be regenerated, a “**filter change without program start**” must be carried out.

6.4. Regeneration of Filter 1 only

ATTENTION: This option is only shown in series and parallel connections.

Select **Regen. Filter 1** in the **Manual Control** menu in order to carry out a regeneration of filter 1 only, without carrying out a water meter reset.

Filter 1 will be regenerated without a reset of the value of the water meter and without a renewed calculation of the filter capacity.

6.5. Regeneration of Filter 2 only

ATTENTION: This option is only shown in series and parallel connections.

Select **Regen. Filter 2** in the **Manual Control** menu in order to carry out a regeneration of filter 2 only, without carrying out a water meter reset.

Filter 2 will be regenerated without a reset of the value of the water meter and without a renewed calculation of the filter capacity.

6.6. Regeneration of the standby filter

ATTENTION: This option is only shown in the case of an exchange connection.

Select **Regen. Standby** in the **Manual Control** menu for a regeneration of the filter that is in standby position. The water meter is reset and the filter capacity is recalculated.



6.7. Filter change without program start

ATTENTION: This option is only shown in the case of an exchange connection.

If one water meter per filter is used, it may occur that a nearly saturated filter is switched into the standby position. If a regeneration of another filter is now desired, the standby filter will be switched into service. Since the filter is nearly saturated, a regeneration for this filter will also be desirable, because if such is not carried out, a "Capacity Exceeded" message may occur.

In the menu, select **Manual Control – Change filter** in order to switch to the other filter.

6.8. Manual start of complete regeneration

ATTENTION: This option is only shown when proportional brine has been activated (see § 12.3.5 "Proportional Brine" on page 40).

With this option it is possible to make a complete regeneration when a filter is not completely exhausted.

Select in the menu **Manual – Start Compl. Regen.** for making a complete regeneration by hand.

6.9. Manual start of refresh

ATTENTION: This option is only shown when alternating service and refresh function are activated. (see § 12.2 "Installation type" on page 32, "alternate standby")

With this option it is possible to refresh the standby filter manually.

Select in the menu **Manual – Start Refresh** for making a refresh by hand.

7. Manual Control during regeneration

Below, all manual options that are possible when a filter is regenerating are described.

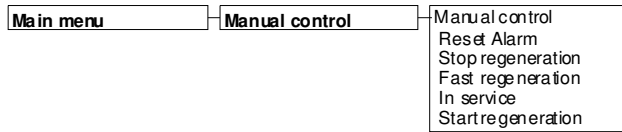

7.1. Reset alarm

If an alarm situation has occurred, a message will always appear in the LCD display. Depending on the programming (See §12.4 “Alarm”, page 41), the built-in buzzer and/or one or more alarm outputs will be activated.

By means of the menu option **Reset Alarm**, the buzzer, the alarm output or the message can be switched off. The flow diagram below shows which action is required when **Reset Alarm** is carried out.

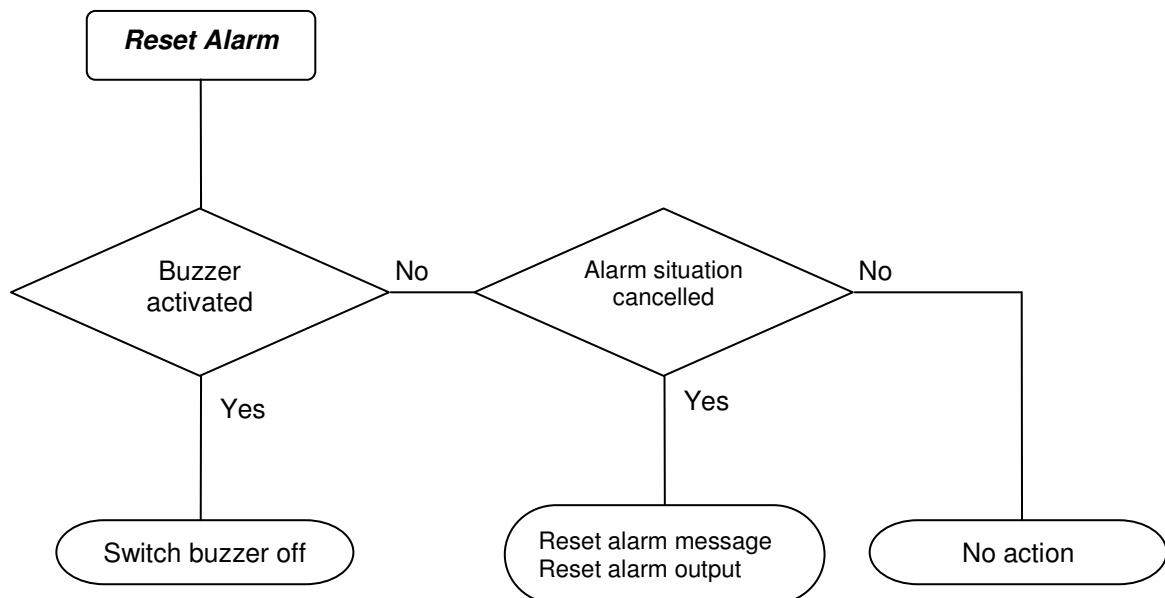

7.2. Stop Regeneration

A currently running regeneration process is ended and the installation is switched into the service position.

In the menu, select **Manual Control – Stop Regeneration** in order to stop the current regeneration immediately.

ATTENTION: If regeneration substances have already been sucked in, the filter must be washed out before taking it into service.

7.3. Accelerated regeneration

The selection of the menu option “Accelerated regeneration” will convert the lapse of time of the current regeneration phase from minutes into seconds. The “high-speed” that is switched on exclusively applies to the current regeneration phase. The normal lapse of time applies to the next phase again.

To accelerate the progress of the program of the current phase, select **Manual Control - Accelerated regeneration** in the menu. The high-speed will not be activated if one of the motors is driven; wait until the motor has reached its new position and then carry out the next “high-speed”.



ATTENTION: In order to go through the various regeneration phases by means of the **“Accelerated regeneration”** function, a three-minute waiting period should be taken into account in order that the motor reaches its new position.

ATTENTION: If regeneration substances have already been sucked in, the filter must be washed out before putting it into service.

7.4. In service

ATTENTION: This option is only shown if the alarm situation “Capacity exceeded” is active. For further explanation about “Capacity exceeded” see: §14.1 Installation capacity exceeded”, page 47.

Select **Manual Control – In service** in order to put the saturated filter into service again.

Using this option it is possible to put the last filter that is saturated into service again. Note that this filter may supply untreated water.

7.5. Start regeneration manually in case of an alarm message

If a filter wants to start a regeneration when this is not possible because all the conditions have not been met, it is yet possible to start a regeneration via **Manual Control – Start Regeneration**.

These conditions include: delayed regeneration, minimum regeneration distance, capacity exceeded, input wait or input lack of chemicals.

Now select **Manual Control – Start Regeneration** in the menu in order to carry out a manual regeneration.

8. Requesting information

Various data can be requested via the information menu, such as: the software version, the service telephone number, the programming and status of the inputs and outputs, the filter capacity, the history information, the maintenance interval (if programmed).

Under history, the following data can be requested:

- Number of days since the last regeneration.
- Water production since the last regeneration.
- Total number of regenerations implemented.
- Residual capacity filter from 1 to 7 days ago.
- Residual capacity filter from 2 to 7 days ago.
- Total water production from 1 to 63 days ago.
- Number of days that the control has been in service.
- Total amount of water production.

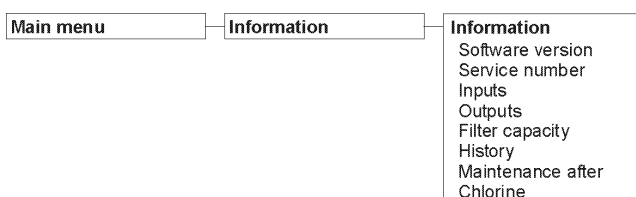

8.1. Software version

The software is maintained in the factory on a regular basis. If necessary, changes take place, in order to adapt the product to new insights and demands.

```

Software version
Type          FCS3000
Version       1.00.00
  
```

8.2. Service number

In the display, information about the service telephone number is shown. Also see §13.1 "Telephone number", page 43.

```

Service number
+31 12 345 67 89
  
```

The following conditions are displayed:

First line : Name of the current sub menu.
 Second line : Telephone number for reporting of possible malfunctions.

8.3. Inputs

Here, the programmed functions and the current status of the inputs can be viewed. The current status of the inputs are updated every second. Also see §12.1.2 "Inputs", page 25.

First line : Name of current sub menu.
 Second line : Function of input 1, e.g. chemicals tank (CT 1). (This function is not active. That means that the chemicals tank is full)

Third line : Function of input 2, e.g. start regeneration (ST2). (This function is active, which means that there is a request to start regeneration via this input)

```

Inputs
>Input 1 CT1 Off
Input 2 ST2 On
  
```

ATTENTION: If "**Input 1 – off**" or "**Input 2 - off**" is shown in the display, then this means that no function has been programmed for input 1 or 2.

8.4. Outputs

This is where the settings and current positions of the outputs can be viewed.

- First line : Name of the current sub menu.
 Second line : Output service valve 1 with current status.
 Third line : Output service valve 2 with current status.
 Fourth line : Function of output 1 with current status.

Outputs

```
>Output SV 1      On
Output SV 2      On
Output 1 FP      Off▼
```

Continuation,

- First line : Name of current sub menu.
 Second line : Output service valve 2 with current status.
 Third line : Function of output 1 with current status.
 Fourth line : Function of output 2 with current status.

Outputs

```
>Output SV 2      On▲
Output 1 FP      Off
Output 2 -       Off
```

8.5. Exchange capacity

Here, the exchange capacity of the filters is displayed. This is displayed in m³.°D (Also see §10 "Setting the hardness", page 20 and §12.1.4 "Filters", page 30)

- First line : Name of the current sub menu.
 Second line : Exchange capacity of filter 1.
 Third line : Exchange capacity of filter 2.

Exchange capacity

```
Filter 1      10m3.°D
Filter 2      10m3.°D
```

8.6. History

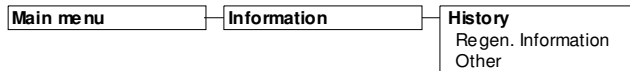

Under “**History**”, data about the status of the control and the history of, for instance, the water production after the last regeneration, can be requested.

Under “**Regen. Information**”, data related to the regenerations can be viewed and under “**Other**”, data related to the remaining water production and capacity can be requested.

8.6.1. Regeneration information

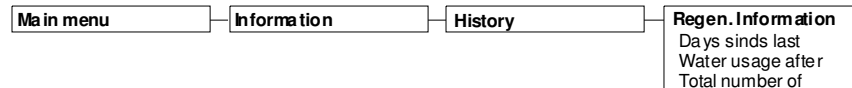

Here, data about the number of days ago that a regeneration was carried out can be requested, as well as the water production since the last regeneration, or the total number of regenerations carried out.

Last regeneration

The number of days since the last regeneration is displayed.

**Days since last
regeneration**
0 Days

Water production since last regeneration

The amount of water produced since the last regeneration is displayed. In the case of parallel service this is the total water production of both filters.

**Water usage after
last regeneration**
12,100 m³

Number of regenerations

The total number of executed regenerations is displayed, since either the first start-up or the last reset.

**Total number of
regenerations**
2

8.6.2. Other information



Here, the data can be requested about the residual capacity of filter 1 and 2, up to 7 days ago. The total water production per day of all connected filters up to 63 days ago. The number of days that the control is in service. And the total water production since the installation has been in service.

Residual capacity filter 1 of 7 days

The residual capacity of filter 1 x number of days ago is displayed. The data of a maximum of 7 days ago are stored in the control.

- First line : Name of the current sub menu.
 Second line : The day of which the information is displayed. In this case yesterday.
 Third line : Residual capacity of filter 1 x number of days ago. Here, yesterday's residual capacity is now displayed.

```

Res. cap. filter 1
Yesterday
12,100 m³
  
```

Control: press **“Up”** one day backward, press **“Down”** one day ahead.

Residual capacity filter 2 of 7 days

The residual capacity of filter 2 of x number of days ago is displayed. The data of a maximum of 7 days ago are stored in the control.

- First line : Name of the current sub menu.
 Second line : The day of which the information is displayed. In this case today.
 Third line : Residual capacity of filter 2 from x days ago. Here, the residual capacity from today is now displayed as of 0.00 hours.

```

Res. cap. filter 1
Today
12,100 m³
  
```

Control: press **“Up”** one day backward, press **“Down”** one day ahead.

Water production of 63 days

It is possible to look at the total water production per day of the past 63 days. The water production of x days ago is displayed.

- First line : Name of the current sub menu.
 Second line : The day of which the information is displayed. Here it is displayed that it concerns 2 days ago.
 Third line : Water production per day of x days ago. Here, the water production of 2 days ago as of 0:00 hours is displayed.

```

Water usage
2 Days ago
10,200 m³
  
```

Control: press **“Up”** one day backward, press **“Down”** one day ahead.

Servicedays

Here, the number of days that the control has been in service is displayed.

Servicedays

10 Days

Total water production

The total amount of produced water since the control has been in service is displayed here. This is the water production of all connected filters.

Total water production

210,200 m³

8.7. Maintenance

Here, the total quantity of water that the installation can still supply, the remaining interval time or the remaining number of regenerations before a maintenance alarm will activate. This information is only visible if a service interval has been programmed at §13.3 "Maintenance interval", page 43.

Maintenance after

Cap. 1,000 m³

Time 1000 h

Regeneration 100 *

8.8. Chlorine production

The programmed and measured current will be displayed. This information will only be shown when the optional circuit board IF-FCS3000 is connected and the chlorine control has been activated (see 12.1.6 "Chlorine production" on page 31).

Chlorine

Current 100 000

9. Changing the language setting

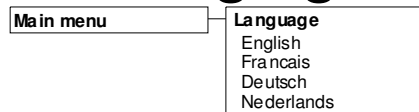

The standard control features for various languages.

It is possible to change the display texts to another language via **Main Menu - Language**.

Changing the language

The current language is marked by "☐". Use the "Up" and "Down" keys for selecting the new language and confirm this using the "Menu" key "☐" which now becomes "☐". Leave this menu by pressing the "Esc" key.



9.1. Changing the language back to the factory setting

If the language of the control has been changed, the factory setting can be set again by following the procedure stated below. This can only be carried out if no regeneration is taking place.

If a regeneration is active, then this regeneration should be awaited until it is finished or it should be stopped using the following actions.

Stopping of regeneration: "Menu", "Menu" and then the second item from the top should be selected, after which "Menu" should be pressed twice in order to actually stop the regeneration. The motor will return to its service position. Wait a short while before continuing.

Changing back to a language: "Menu", then use the "Down" key to go to the last item (press 6x) and use the "Menu" key to enter this sub menu. Now use the "Up" key to go to the top item (probably pressing 4x) and confirm this using the "Menu" key. The control now jumps back to the English language.

10. Setting the hardness

THESE FUNCTIONS SHOULD EXCLUSIVELY BE CHANGED BY A WATER TREATMENT EXPERT; INCORRECT USE MAY LEAD TO UNDESIRABLE MALFUNCTIONS.

Main menu	Hardness	-D
	Unit	
	Value	18

Via "**Hardness**", the selected hardness of the not purified water can be read and changed.

Changing of unit

The current unit is marked by "□". Use the "Up" and "Down" keys to select the new unit and confirm this using the "Menu" key "□" which now becomes "□". Leave this menu by pressing the "Esc" key.

Unit	
> °D	□ ▲
°E	□
°F	□ ▼

The following values and their accompanying ranges can be changed:

Hardness units	Range
°D	1 – 990
°E	1 – 990
°F	1 – 990
ppm	1 – 990
gpg	1 – 990
- (no value)	-

(0,02 mmol/l = 0,10°D = 0,13 °E = 0,18 °F = 1,79ppm = 0,11gpg(USA) = 0,13gpg(UK))

Changing the value

The hardness of the not purified water can be raised/lowered using the "Up" and "Down" keys. Using the "Esc" key, the change can be cancelled and the changes are stored by using the "Menu" key.

Hardness Value	18
-----------------------	-----------

The value of the hardness can be entered without a correction in the following situations.

- No use is made of a hardening installation.
- No use is made of a turbo water meter.
- An impulse water meter has been fitted upstream of the hardening installation.

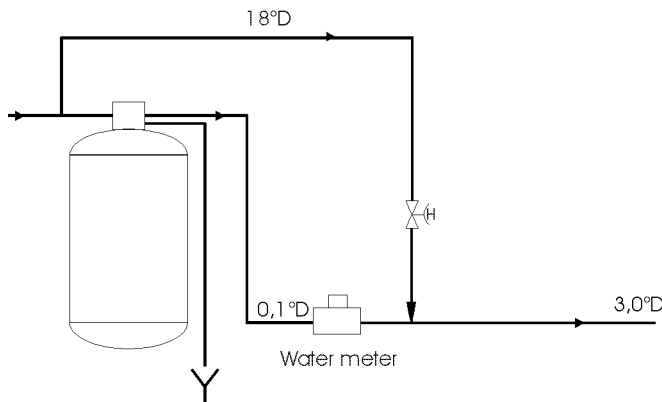



Hardening installation:

If the turbo water meters are not being used, and a water meter is present downstream of a hardening installation, then the water meter will register the amount of hardened water. See also the drawing below.

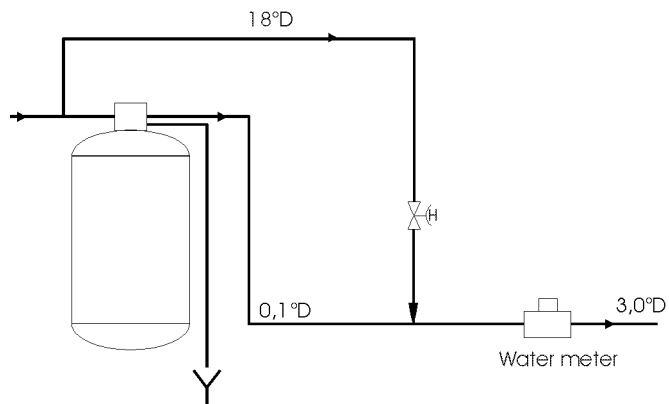

Now the hardness must be corrected according to the following calculation.

Example:

Hardness of not purified water = 18 °D

Hardening = 3 °D

From this results a value to be entered of:

$18\text{ °D} - 3\text{ °D} = 15\text{ °D}$

The calculation of the period capacity (the amount of hardened or softened water) with changed values follows every time at the start of regeneration, as follows.

$$\frac{\text{exchange capacity}(m^3 \cdot \text{°hardnessunit})}{\text{water hardness}(\text{°hardnessunit})} = \text{softened water}(m^3)$$



11. Changing the clock

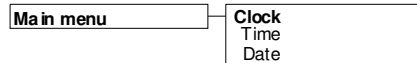

The current date and time can be changed in the "**Clock**" menu.

11.1. Time

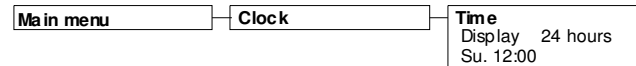

In the menu option "**Time**", the display of the clock and the current time can be set.

Changing the display:

Select the desired display using the "**Up**"/"**Down**" keys and confirms this using the "**Menu**" key. Leave the menu with the "**Esc**" key.

Display	
12 hours	<input type="checkbox"/>
>24 hours	<input checked="" type="checkbox"/>

Changing the current time:

Select the choice of data that have to be changed using the "**Up**"/"**Down**" keys, and press the "**Menu**" key to jump to the next menu. The value can be adjusted using the "**Up**"/"**Down**" keys. Confirm this change with the "**Menu**" key. Leave the menu with the "**Esc**" key.

Time	
>Week day	Su
Hours	12
Minutes	00

11.2. Date

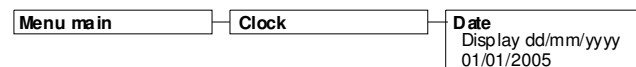

Changing the display:

Select the desired display using the "**Up**"/"**Down**" keys and confirms this using the "**Menu**" key. Leave the menu with the "**Esc**" key.

Display	
>dd/mm/yyyy	<input checked="" type="checkbox"/>
mm/dd/yyyy	<input type="checkbox"/>
yyyy/mm/dd	<input type="checkbox"/>

Changing the current date:

Select the choice of data that have to be changed using the "**Up**"/"**Down**" keys, and press the "**Menu**" key to jump to the next menu. The value can be adjusted using the "**Up**"/"**Down**" keys. Confirm this change with the "**Menu**" key. Leave the menu with the "**Esc**" key.

Date	
>Day	1
Month	1
Year	2005

12. Programming

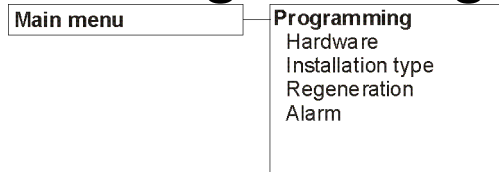

The following chapters describe how the control can be programmed. However, this can only be done if no regeneration is active.

A complete overview of all menu options can be found in §16 “Overview menu” on page 53.

The programming menu can be screened off by a security code. The manufacturer’s security code has been set to “4321”. This code can be changed via the menu §13.2 “Change code”, page 43.

The cursor can be moved using the “**Menu**” key and the “**Up**” and “**Down**” key is used to change the selected values. Leave the menu using the “**Esc**” key.

```

Programming
Security code      0000
  
```

12.1. Hardware

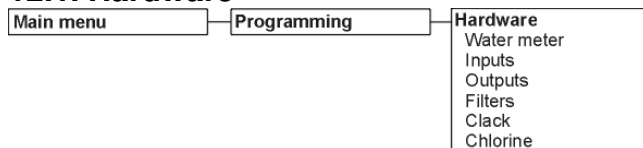

In the following sections there is a description of how all hardware components, such as the water meter, the inputs, the outputs and the filters can be programmed.

12.1.1. Water meter

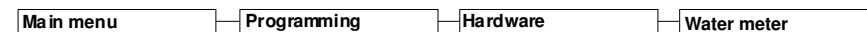

Here, it is programmed whether a water meter is connected and what type of water meter this is.

Using a water meter, it is possible to execute a regeneration based on volume. See §12.3.3 “Start conditions”, page 36 – “Water meter”.

Select the water meter type that is connected.

If the turbo water meter that is supplied with the CLACK control valve is being used, then “**turbo water meter**” should be selected.

The “**impulse water meter**” should be selected if one or two impulse water meters are used.

Select “**None**” if no water meter is connected.

```

Water meter
>Turbo-watermeter  
Impulse-watermeter 
None                
  
```



12.1.1.1. Turbo water meter

Program the turbo water meter if the turbo (WS1 Meter ASY) is used, which can be supplied with the CLACK control valve.

Using this turbo water meter, it is possible to execute a regeneration based on volume. See §12.3.3 "Start conditions", page 36 – "Water meter" as to start regeneration based on water meter.

Pulses/Gallon:

Turbo water meter for 25.4mm (1") series control valves must be set to 68 pulses per American gallon.

Type	Pulses/Gallon
1,00"	68
1,25"	68
1,50"	37
2,00"	20

```
Turbo-watermeter
Pulses/Gallon    64
Volume unit      m3
```

Volume unit:

Select the desired volume unit that must be shown in the display, this can be **GAL** or **m³**. During the programming of **GAL**, the control will convert the volume unit of **m³** into **GAL**.

12.1.1.2. Impulse water meter

If an impulse water meter is connected to input 1 and/or 2, then the number of litres per pulse should be programmed. For the programming of input 1 and/or 2 as a water meter see 12.1.2.5 "Water meter, page 27.

Volume unit:

Select the desired volume unit that must be shown in the display, this can be **GAL** or **m³**. During the programming of **GAL**, the control will convert the volume unit of **m³** into **GAL**.

```
Impulse water meter
>Volume unit      m3
```

12.1.1.3. None

This option should be selected if no water meter has been connected.

12.1.2. Inputs

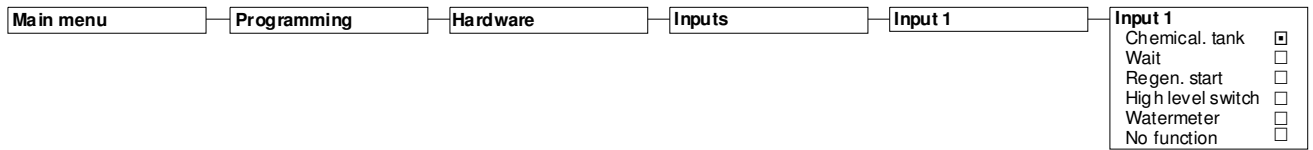

This control has 2 freely programmable inputs. These inputs can be programmed as:

Description	Input
• Monitoring of the chemicals tank	CT
• Waiting during regeneration	WA
• Regeneration start	RS1 and/or RS2
• Level switch(es) of supply tank	LH or LH and LL
• Impulse water meter(s)	WM 1 and/or WM2
• No function	-

ATTENTION: During the programming of the status of the contact for the inputs, it should be taken into account that during a cable cut the function must be active. E.g. If the function level switch is programmed, the contact will be opened in the case of a full tank, which will cause the service valve to close and the filling of the tank to stop. This is also the case if there is a cable cut, because a safety has been built in. (Contact has been programmed as “Nc” in this case)

Changing the setting:

Select the desired input function using the “Up”, “Down” keys and confirm this using the “Menu” key. Then, a sub menu will appear, in which specific settings for this type of input function can be programmed. The method of programming for input 2 is identical to that of input 1.

12.1.2.1. Chemicals tank

Using this function, the chemicals supply for ion exchangers can be monitored. If this function is active while starting regeneration (chemicals tank empty), no regeneration will be started. In the case of duplex installations, the service valve of the saturated filter will close immediately, which causes a switch to the standby filter, and a regeneration of the saturated filter will not be started. In the case of single installations it can be programmed whether the service valve remains open (installation will continue supplying water) or whether it must be closed (installation will stop supplying water). See §12.3.4.5 “Input CT”, page 40.

ATTENTION: This function can be programmed once for one single input, which is for input 1 or input 2.

Contact:

In case of an empty chemicals tank it should be indicated whether the contact is normally opened (**No**) or normally closed (**Nc**). The “Menu” key can be used to switch between Nc and No.

Chemicals tank	
>Contact	Nc
Delay	4s
Ignore	5h

Delay:

The time between the closing/opening of the contact and the activating of this input function is programmable between 0 and 999 seconds. If this value is larger than 0, this means that the input function must be active during the selected delay time for the control to respond.

Ignore:

This is the time the input will be ignored after finishing a regeneration (0 – 99 h).

In the case of duplex filter installations in alternating service, there is a switch to the standby filter. If desired, a regeneration can nevertheless be started via “Manual Control → Start Regeneration”. (See §6.2 “Manual regeneration start”, page 10)

12.1.2.2. Waiting during regeneration

If this input function has been programmed and the input is active before or during the regeneration, then the regeneration cycle will be stopped. Using a hand start, the stop signal can be stopped for the duration of the complete regeneration.

ATTENTION: This function can be programmed once for one single input, which is for input 1 or input 2.

Contact:

Indicate whether a contact is normally opened (**No**) or normally closed (**Nc**) during an interruption of a regeneration. The “**Menu**” key can be used to switch between Nc en No.

Delay:

The time between the closing of the contact and the activating of this input function is programmable between 0 and 999 seconds. If this value is larger than 0, this means that it takes the selected delay time before the control is to respond to this input function.

Wait	
>Contact	Nc
Delay	4s

ATTENTION: In the case of single installations it can be programmed whether the service valve remains open up to the regeneration start (filter continues supplying water) or whether it is being closed (filter no longer supplies water). (See §12.3.4.4 “Input WA ”), page 40. In the case of a duplex installation, the service valve will always be closed and there will be a switch to the standby filter. Application examples: delaying of the regeneration start, extension of the regeneration phase or the interruption of the regeneration.

12.1.2.3. Regeneration start

Via this input, a regeneration of the service filter can be activated externally via a push button or by means of a water analysis, for instance. In the case of an alternating service, the standby filter is called into service.

ATTENTION: This function can be programmed for both input 1 and input 2. Once an input Regeneration start has been programmed, this input will be linked to filter 1 and filter 2. If input 1 and input 2 have been programmed as regeneration start, then input 1 will be linked to filter 1 and input 2 to filter 2 in order to start a regeneration.

Contact:

Indicate whether a contact is normally opened (**No**) or normally closed (**Nc**) during a regeneration start. The “**Menu**” key can be used to switch between Nc en No.

Delay:

The time between the closing/opening of the contact and the activating of this input function is programmable between 0 and 999 seconds. If this value is larger than 0, then this means that it takes the selected delay time before the control will respond to this input function.

Ignore:

This is the time between the activation of the input function and the renewed check of the input. Note that a new regeneration will only be started if the input has been deactivated and then becomes active again. The ignore time can be set between 0 and 999 seconds.

Regen. start	
>Contact	No
Delay	4s
Ignore	600s

ATTENTION: After the delay time a regeneration will be started at time point T1. Next, the ignore time will be started and if this is over, a new regeneration start will be permitted again. A new regeneration will only then be started if the input has been deactivated and then becomes active again. This suppresses undesired start

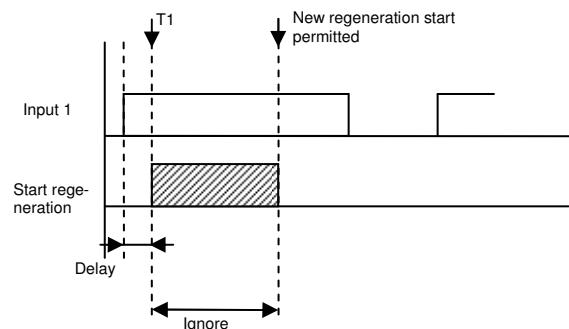

pulses of a hardness monitor, for instance. See also the drawing alongside.

If under §12.3.4 “Stop conditions”, page 38 the “**delayed regeneration**” has been programmed, then the time function is activated and the time point at which the automatically delayed regeneration start occurs will be displayed on the second line of the LCD display. No regeneration will take place.

If under §12.3.4 “Stop conditions”, page 38 the “**minimum regeneration distance**” has been programmed, then the following message will appear during a starting attempt within the selected time interval:

Minimum regeneration distance “minimum regeneration distance” and no regeneration is started (see “Messages” – §14.6 “Minimum regeneration distance”, page 48).

12.1.2.4. Level switch

Via this input the refilling of a supply tank, for instance, can be adjusted. It is possible to use 1 (high) or 2 (high and low) level switches.

One level switch (High level); if only input 1 is programmed as a level switch, it will function as a high level switch (LH). Depending on the position of the input, the service valve will close/open and switch off/on the possibly programmed feed pump if no regeneration is active.

Two level switches (High and low level); if both inputs have been programmed for level switches, then input 1 will be a high level switch (LH) and input 2 will be a low level switch (LL). Depending on the position of the input, the service valve will close/open and switch off/on the possibly programmed feed pump if no regeneration is active.

Contact:

Indicate whether a contact is normally opened (**No**) or normally closed (**Nc**) in case of an empty supply tank. The “**Menu**” key can be used to switch between Nc en No.

Delay:

The time between the closing/opening of the contact and the activating of this input function is programmable between 0 and 999 seconds. If this value is larger than 0, then this means that it takes the selected delay time before the control will respond to this input function.

High level switch	
>Contact	Nc
Delay	4s

12.1.2.5. Water meter

ATTENTION: This option is only programmable if under §12.1.1 “Water meter”, page 23 , the “Impulse water meter” has been programmed.

Using this input function, it is possible to connect and programme an impulse water meter and to carry out a regeneration based on volume. See §12.3.3 “Start conditions”, page 36 – “Water meter” as to start regeneration based on the water meter.

If 1 water meter has been programmed, then it is used for all connected filters. If 2 water meters have been programmed, then water meter 1 is linked to filter 1 and water meter 2 to filter 2.

Litres/pulse:

The number of litres per pulse can be programmed within a range of 1.0 – 1,000.0 litres per pulse.

Water meter	
>	100,01/p

The amount of water that is available until the next regeneration is shown in the LCD display.

12.1.2.6. No function

If an input is not used, it should be set to “No function”.

12.1.3. Outputs

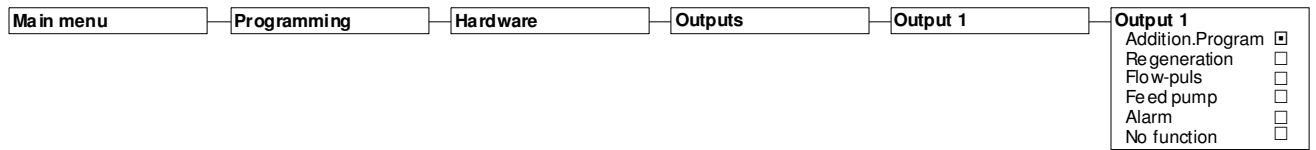

This control has 2 freely programmable potential free outputs. These outputs can be programmed as follows:

- Additional program AP1 and/or AP2 (APx is linked to filter 1 **and/or** filter 2)
- Regeneration RE1 and RE2 (RE1 is for filter 1, RE2 is for filter 2)
RE1 or RE2 (REx is linked to filter 1 **and** filter 2)
- Flow-pulse FL1 and/or FL2
- Feed pump FP1 and FP2 (FP1 is for filter 1, FP2 is for filter 2)
FP1 or FP2 (FPx is linked to filter 1 **and** filter 2)
- Message/Alarm AL1 and AL2 (AL1 is for filter 1, AL2 is for filter 2)
AL1 or AL2 (ALx is linked to filter 1 **and** filter 2)
- No function -

ATTENTION:

- If **different** functions are programmed for output 1 and output 2, the outputs will be linked to both filter 1 and filter 2.
- If the same output functions are programmed for output 1 and output 2, then output 1 is linked to filter 1 and output 2 is lined to filter 2.

Changing of settings:

Select the relevant output function using the “Up”, “Down” keys and confirm this using the “Menu” key. Next, a sub menu will appear in which specific settings for this type of output function can be programmed. Leave this menu using the “Esc” key. The way of programming of output 1 is identical to that of output 2.

12.1.3.1. Additional program

During the regeneration of a filter an extra output can be addressed before, during or after the regeneration. By doing this, a rinse process can be executed or the feed or dose pump can be switched on. During the next steps, the switch-on point, the time period and possibly the delay of the output are determined.

Start phase:

This is the switch-on point of the additional program. This can be “before” the calling of the regeneration, the start of “**phase 1 – phase 10**” or “after” the regeneration. If “before” is selected as start phase, Zthen the additional program will run before the actual regeneration process. If “after” is used as start phase, then the additional program will be executed after the regeneration has finished.

Length:

The duration of the additional program is programmable between 0 and 255 minutes.

Delay:

This option is only programmable if the start phase “**phase 1- phase 10**” has been programmed. This is the delay between the activation of the regeneration phase and the activation of the output of the additional program. (See the drawing as well). The delay is programmable between 0 and 255 minutes.

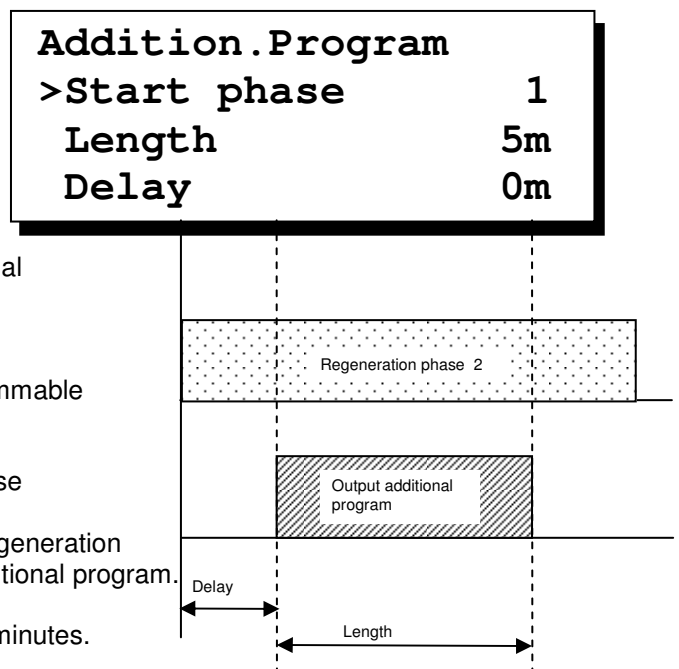

Service valve:

This option is only programmable if the start phase "before" has been selected.

The additional program will be executed before the actual regeneration process. It can now be programmed whether the service valve of the filter to be regenerated should be instantly closed ("Closed") upon switching on the additional program, or whether it should be closed after the program has been completed ("Open").

In the case of duplex filter installations in alternating service this determines whether upon switching on the additional program there is an instant switch to the standby filter ("Closed") or whether this only happens after completion of the additional program ("Open").

Filter 1:

"On" : The function will be activated for filter 1

"Off" : Function switched off for filter 1

Filter 2:

"On" : The function will be activated for filter 2

"Off" : Function switched off for filter 2

12.1.3.2. Regeneration course

If the function "Regeneration" is selected, the relevant output is activated for the entire duration of the regeneration.

There are no programming options for this output function.

12.1.3.3. Flow-pulse

An extraction impulse will take place as soon as the extraction pulse has registered the set quantity of water (Pulse distance). These pulses can be used for controlling the proportioning pump, a proportioning controller or as a flow switch. In case large quantities of water are drained, the internal memory will keep the amount of water generated and the extraction pulses will occur every 1 second.

Pulse distance:

This is the amount of water that has to be measured before the extraction pulse takes place. The pulse distance can be set from 1 to 999 litres.

Pulse time:

The pulse time represents the period the relays have to be switched on during an extraction pulse. The pulse time can be set from 0.5 to 999.9 seconds.

Flow-pulse	
>Pulse period	100l
Pulse time	1.0s

12.1.3.4. Feed pump

An feed pump is used for duplex filter installations, so as to make sure that there is sufficient water pressure during a regeneration, so that water can be supplied for the filter that is in service as well as for the filter that is regenerating.

If the function "Feed pump" is selected, the relevant output is activated during regeneration, provided that no input has been programmed as level switch. And it is switched off as soon as the regeneration has finished.

If an input has also been programmed as level switch under § 12.1.2 "Inputs", page 25, then the feed pump will only be activated if a regeneration is active and if the level input has been activated.

A switch-off will take place if the supply tank has been filled or if the regeneration has terminated.

12.1.3.5. Alarm

During service and during the regeneration of the installation, various alarm signals may occur that may activate output 1 or output 2. The programming of the alarms on the outputs can be found in "Alarm 1", page 42 and § 12.4.4 "Alarm 2", page 42.

ATTENTION: If an output has been programmed as alarm, then, during normal service without an alarm situation, a connection between contacts 11-12 will apply to output 1 and 14-15 to output 2. As soon as an alarm situation arises, the relevant output will switch and a connection will be made between 11-13 for output 1 and 14-16 for output 2.

Because of this, it is also possible to detect a power supply failure of the control; an "unusual" voltage via output 1 or output 2 will be noticed.

12.1.3.6. No function

If an input is not used, it should be set to “No function”.

12.1.4. Filters

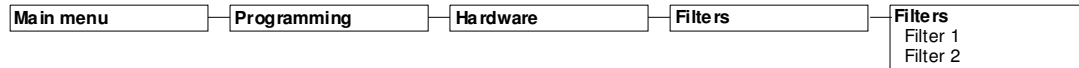

Under the option Filters, settings can be entered for the connected filters, such as the status of the filters and the capacity of the filters.

Single service:

Filter 1 (Filter 2):

If “Single” service is selected under § 12.2 “Installation type”, page 32, it is possible to indicate to which output this filter is connected. “On”: filter connected. “Off”: filter not connected.

Capacity:

Setting of the filter capacity of filter 1 displayed in m³ hardness, in which “°hardness” is the selected hardness unit. Select this menu option using the “Menu” key in order to change the value.

```

Filter 1
>Filter 1           On
Capacity           10
  
```

ATTENTION: Upon reaching the maximum value there is an automatic jump back to the minimum value. Upon reaching the minimum value there is an automatic jump to the maximum value.

A value of 1 to 65000 m³ hardness can be entered for the filter capacity. The raising is done according to the table below.

Range	Modification steps
1 – 75	1
76 – 400	5
401 – 65000	10

Filter capacity

Softening installation: The physical unit of the filter capacity depends on the selected unit of the hardness of the unpurified water. This can be set in § 10 “Setting the hardness”, page 20.

The amount of softened water per filter is automatically calculated as follows:

$$\frac{\text{Filter capacity}(\text{°hardness unit} \cdot \text{m}^3)}{\text{Hardness of water}(\text{°hardness unit})} = \text{softened water}(\text{m}^3)$$

Example 1 :

$$\frac{1800^{\circ D} \cdot \text{m}^3}{18^{\circ D}} = 100 \text{m}^3$$

Example 2 :

$$\frac{2020^{\circ F} \cdot \text{m}^3}{18^{\circ F}} = 112.2 \text{m}^3$$

ATTENTION: If, under §12.2 “Installation type”, page 32– “Serial” – “Cap. differences” is on “Yes”, then the filter capacity for each individual filter will have to be entered. In all other cases the filter capacity has to be entered once at filter 1, and that same value then applies to filter 2.

FILTER installations: If under § 10 “Setting the hardness”, page 20, no unit for the hardness of not purified water was selected, then the range of the filter capacity is 5 to 65000 m³.

12.1.5. Clack valve

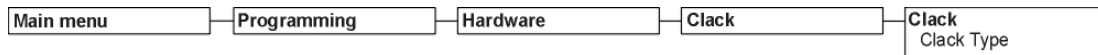

Here you can enter the settings for the Clack valve.

Clack Type:

The valve type (with regard to the motor positions) can be entered.

0 = WS1, WS1.25 en WS1.5

1 = WS2

```

Clack
>Clack Type      0
  
```

If the type has been changed, the motor of the valves is set in the correct position upon exiting the programming.

12.1.6. Chlorine production

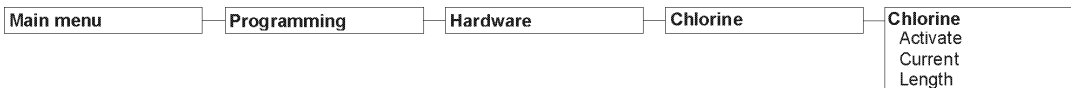

With this option the parameters for the current output for chlorine production can be programmed.

ATTENTION: This option is only shown when the optional circuit board IF-FCS3000 is connected.

Activate:

The function for chlor production can be activated (Yes) or not (No). When the function is activated the current output will be switched on during brine.

```

Chlorine
>Activate      Yes
Current      100mA
Length      20m
  
```

Current:

The current for production of chlorine during brine can be programmed (100-500mA).

Length:

The duration of the chlor production is programmable between 0 and 255 minutes.

Delay:

This is the delay between the activation of the regeneration phase and the activation of the output for chlor production. The delay is programmable between 0 and 255 seconds.

When this function is activated, the current output will be checked. If the current is not correct you can activate a message (see § 12.4 "Alarms" on page 41).

12.2. Installation type

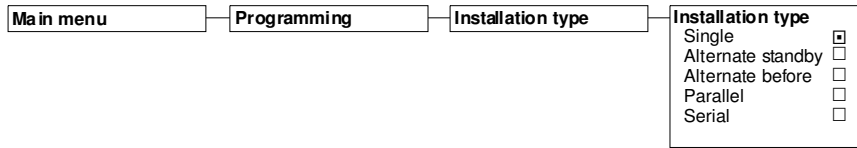

Here, the installation type can be programmed.

Single

In the case where the installation consists of one filter. Also see §12.1.4 “Filters”, page 30. Thanks to the option between “filter 1” and “filter 2” in §12.1.4 “Filters”, page 30, one filter can be rapidly put out of service if necessary and if it concerns a duplex filter installation.

Alternate standby

A duplex filter installation usually works in exchange connection. In this system, one filter supplies softened water while the other filter is in standby mode or is being regenerated. Upon “change standard”, the saturated filter will be regenerated and then go into standby until the other filter is saturated.

When a water meter or turbine is connected, it is possible to switch, after a programmable interval time, shortly to the standby filter. This can be done for hygiene purposes.

Refresh:

The function “Refresh” can be activated (**Yes**) or not (**No**).

Time:

The interval time for switching to the standby filter can be programmed between 1 and 500 hours.

```

Alternate standby
>Refresh           Yes
Interval time     12h
Volume            1001
    
```

Volume:

After production of a certain amount of softened water the installation will switch back to the “main” filter. A volume between 1 and 5000 liters can be programmed.

Change, regeneration for service

A duplex filter installation usually works in exchange connection. In this system, one filter supplies softened water while the other filter is in standby mode or is being regenerated. Upon “change, regeneration for service”, the standby filter will first be regenerated before it is put into service. Next, the saturated filter will go into standby. ATTENTION: This should be taken into account when calculating the exchange capacity.

See also the diagram below.

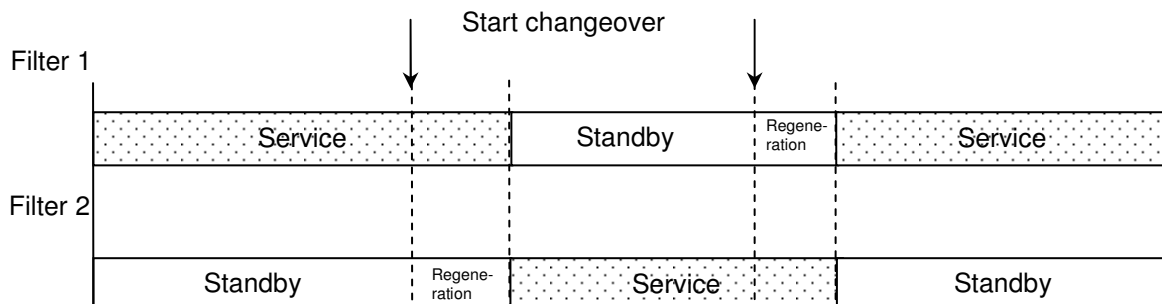



Parallel

It is also possible to switch a duplex installation into parallel service if a large extraction capacity is demanded for a short period of time. Except during a regeneration, both filters simultaneously supply softened water.

If, during the start of a regeneration, the residual capacity of the filter in service is larger than 50% of the exchange capacity, the residual capacity will be set back to 50% of the filter capacity.

Example 1:

Filter exchange capacity 250m³

Filter 1 Regeneration

Filter 2 residual capacity 230m³ -> This will be set back to 125m³.

Example 2:

Filter exchange capacity 250m³

Filter 1 Regeneration

Filter 2 residual capacity 100m³ -> Residual capacity remains equal.

Serial

Serial service applies to duplex filter installations in which the filters are connected in series. Example: single decarbonising (particle desalination) installation with an H-exchanger and an Na-exchanger.

Ratio:

The redress life of the Na-ion exchangers can be several times longer than that of the H-ion exchanger in the case of decarbonising installations. For this purpose it is possible to enter a regeneration ration of 1:1 to 9:1.

Serial	
>Ratio	3:1
Reg.prog.diff.	No
Cap.different	No

Example: In the event of the programming of the ratio 2:1 for instance, the Na-exchanger will also be regenerated after the second regeneration of the H-exchanger.

Reg.prog.diff.: (Different Regeneration program)

Yes = regeneration program of the filters are different. Under §12.3.2 "Regeneration", page 34, the regeneration program for the second filter must also be programmed.

No = filters have the same regeneration program.

Cap. different: (Capacity different)

Yes = filters have a different exchange capacity. Under §12.1.4 "Filters", page 30, the capacity for filters 1 and 2 must now be programmed.

No = filters have the same capacity.



12.3. Regeneration settings



Here, settings are made with respect to the regeneration and the regeneration course. The following options can be programmed.

12.3.1. Switch steps

Number of regeneration switch steps, minimum of 1 and maximum of 10 phases.

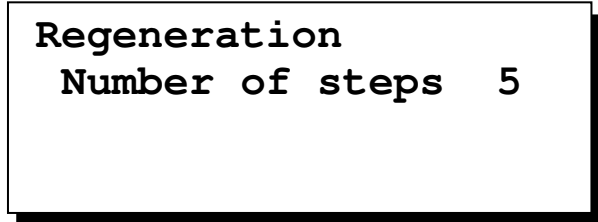

12.3.2. Regeneration process

The order of the various regeneration steps is freely programmable.

Using the “Up” and “Down” key, select the relevant phase that must be changed and jump to the next sub menu using the “Menu” key, in order to select the correct phase and determine the length. Leave the menu via the “Esc” key.

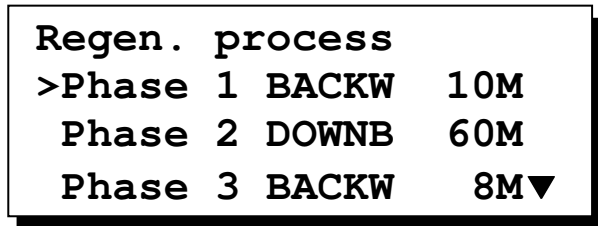

Phase:

These are the regeneration phases that must be passed through during a regeneration.

The possible programmable phases are:

- Fill (filling of the chemicals tank)
- Backwash (washing backwards)
- Up Brine (upward feeding through of chemicals)

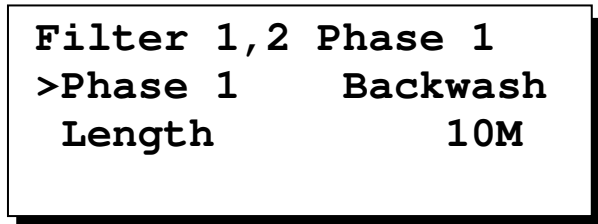

- Down Brine (downward feeding through of chemicals)
- Rinse (fast rinse)
- Softener/Filter (Phase that is used if the regenerant is refilled/produced before the start of the regeneration)

Note: the filter is in service during this phase. After the last regeneration phase the control will return to the service position.

- Wait During this phase the motor will be in service position.

Length:

Duration of the selected regeneration phase, the range is from 1 to 1200 minutes.

The standard regeneration process is built up as follows:

- Phase 1: Backwash 10 minutes
- Phase 2: Down brine 60 minutes
- Phase 3: Backwash 8 minutes
- Phase 4: Rinse 4 minutes
- Phase 5: Fill 3 minutes



Example of regeneration processes for softening and filter installations:

Regeneration process for a softening installation.

Downward regenerating, chemicals tank refill, rinse.		Downward regenerating, chemicals tank fill for the regeneration.		Upward regenerating, chemical tank fill, rinse.		Upward regenerating, chemicals tank fill for the regeneration.	
backwash	8 min.	fill	3 min.	up brine	60 min.	fill	3 min.
down brine	60 min.	softener	240 min.	backwash	8 min.	softener	240 min.
backwash	8 min.	backwash	8 min.	rinse	4 min.	up brine	60 min.
rinse	4 min.	down brine	60 min.	fill	3 min.	backwash	8 min.
fill	3 min.	backwash	8 min.			rinse	4 min.
		rinse	4 min.				

Regeneration process for a filter installation.

Downward regenerating, chemicals tank refill after rinse.		Downward regenerating, chemicals tank fill before the regeneration.		No regeneration substance.	
backwash	8 min.	fill	3 min.	backwash	8 min.
down brine	60 min.	filter	240 min.	rinse	4 min.
backwash	8 min.	backwash	8 min.	backwash	8 min.
rinse	4 min.	down brine	60 min.	rinse	4 min.
fill	3 min.	backwash	8 min.		
		rinse	4 min.		

12.3.3. Start conditions

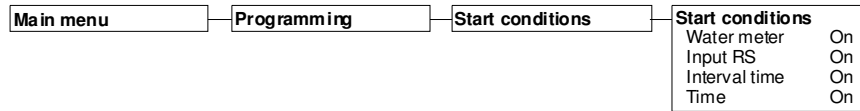

By start conditions are understood all possible signals and contacts that are required to start a regeneration. The following options can be programmed.

12.3.3.1. Water meter (impulse/turbo)

A regeneration based on a pulse/turbo water meter can be started if this has been programmed. For this purpose, see §12.1.1 “Water meter”, page 23 and §12.1.2 “Inputs”, page 25. This menu option will not be visible if no pulse/turbo water meter has been programmed.

Start:

- On** = a regeneration is started based on the water meter.
- Off** = no regeneration based on the water meter is started.

Water meter	
>Start	On
Precontact	On

Precontact:

Indicates if the precontact has been programmed. The programming of the precontact is described in the next sections.

12.3.3.2. Precontact

It is often desirable to receive a message or to signal another device before saturation is reached.

Start:

- On** = a message is given when the preset saturation percentage is reached.
- Off** = no message will be given.

Precontact	
>Start	On
Percentage	85%
Regen. start	On

Percentage:

Limit values of 1 to 100% of the programmed capacity can be entered. At a filter capacity of for instance 180 m3 between the regenerations and an entered value of 85%, a precontact follows after a consumption of 153 m3.

Reg. start: (Regeneration start)

A regeneration start via the precontact is useful in case of single installations, in connection with the delayed regeneration. (See §12.3.4 “Stop conditions”, page 38). This ensures that sufficient softened water is available for the next day. At a net capacity of, for instance, 180 m3, and a precontact of 85% this results in an amount of treated water of 153 m3.

Example 1: Starting a regeneration based on precontact (85%).

Water meter		Precontact	
Start	On	Start	On
Precontact	On	Percentage	85%
		Reg. start	On

Net capacity of 180 m3 and a precontact of 85%. If a delayed regeneration is used in the case of a single installation, a regeneration will be started after the delayed regeneration time has ended, and a regeneration will be started as soon as less than 27 m3 is available.

Example 2: Start a regeneration via the water analysis device after a minimum consumption of 85%.

Water meter		Precontact	
Start	Off	Start	On
Precontact	On	Percentage	85%
		Reg. start	Off

As soon as the precontact is active, the water analysis device will start determining whether a regeneration is desirable, or if the filter can still supply treated water. However, the regeneration will only be initiated if the water analysis device considers it necessary.

ATTENTION! In order that no untreated water comes near the consumption points, the amount must be sufficient to bridge the time period between the giving out of the precontact and the delayed regeneration.

12.3.3.3. Interval time

A regeneration can also be started with a fixed time interval. This chronological start option is applied if, due to the constant extraction, no water meter needs to be applied. Moreover, this application is used for the prevention of nucleation caused by excessive stand times in combination with a start depending on volume or quality.

Start:

On = regeneration is started based on the preset interval time.

Off = no regeneration based on interval time is started.

Interval:

The duration is programmable between 1 and 999 hours.

```
Interval time
>Start           On
Interval         10h
```

ATTENTION: In the case of installations containing a brine tank, the production of brine should be awaited, i.e. the interval up to the next regeneration should be at least 3 to 4 hours.

As soon as the interval timer has activated, a regeneration will be started if such is permitted. Upon the start of a regeneration, the interval counter will be reset and restarted.

12.3.3.4. Time start

A regeneration can be started depending on the selected week clock. Two different time points (time 1 and time 2) can be programmed per day.

Time 1:

On = a time start has been programmed for time 1.

Off = no time start has been programmed.

Time 2:

On = a time start has been programmed for time 2. "**Off**": no time start has been programmed.

```
Time
>Time 1           On
Time 2           Off
```

Time 1

Changing the settings for time 1.

Start:

On = a regeneration is started on the selected time point 1 and days.

Off = no regeneration based on time start is selected.

Start time:

Time point at which the regeneration of the selected day (s) must be started.

Day selection:

Day(s) on which the filter in service must be regenerated.

```
Time 1
>Start           On
Start time      13:00
Day selection
```

12.3.4. Stop conditions



A regeneration can be blocked or interrupted due to various settings. For instance: delayed regeneration, minimum regeneration distance, capacity exceeded, input function wait, or input function lack of chemicals.

In this menu it can be read whether the functions that may interrupt the regeneration have been activated. In the following sections it will be explained how the stop functions can be programmed.

12.3.4.1. Delayed regeneration

A regeneration can be started at any time during the day. A regeneration during production time is often not desirable, however. For instance because the water pressure is insufficient for the regeneration, a regeneration can be blocked using "delayed regeneration" in such a case.

If it concerns a duplex installation in alternating service, there is a switch to the standby filter in the event of "delayed regeneration", while no regeneration is started.

Stop:

Off = no delayed regeneration.

On = delayed regeneration has been switched on.

Start time:

Time point as from which no automatic regenerations may be started.

End time:

Time point as from which automatic regenerations may be started again.

Day selection:

Days on which the "delayed regeneration" must be active.

Servicevalve:

In the case of a single filter installation, a duplex filter installation that is series connected and in the case of a duplex installation in parallel service, it can be entered whether the valve stays "**Open**" up to the time of regeneration or whether it closes immediately. "**Closed**".

```

Delayed regen.
>Stop                on
  Begin time         06:00
  End time           17:00▼
  
```

```

Delayed regen.
  End time           17:00▲
>Day selection
  Servicevalve      Close
  
```

ATTENTION: If the service valve is closed, there may not be a lack of softened water, unless there is sufficient water in a supply tank until after the regeneration.

If the service valve remains open, then it should be guaranteed that the installation is able to supply treated water until the regeneration.

In the case of a duplex filter installation in parallel service and in delayed regeneration, it can be entered that the service valve of the saturated filter remains "Open" until the delayed regeneration, or that the service valve closes "Close", so that only 1 filter is in service until after the termination of the delayed regeneration.

In the case of a duplex filter installation in alternating service, there is always an immediate switch to the spare filter, irrespective of the programming of the service valve.

Example 1: Start time = 6:00 End time = 18:00

No automatic regeneration start takes place between 6:00 hours and 18:00 hours of that same day.

Example 2: Start time = 17:00 End time = 5:00

No automatic regeneration start takes place between 17:00 hours on the programmed day and 5:00 hours of the next day.

12.3.4.2. Minimum regeneration distance

If a brine production tank is used, the installation needs around 3 to 4 hours time between two regenerations in order to produce a brine solution again. Via the programming of the minimum regeneration distance it can be ensured that there is sufficient time between two regenerations, so that a saturated brine solution will be produced.

Stop:

On = no minimum regeneration distance.

Off = minimum regeneration distance switched off.

Interval time:

Minimum interval time between two regenerations, the value may be between 1 – 99 hours.

Regen.overtake: (Regeneration overtake)

Yes = still carry out a regeneration after termination of the entered minimum regeneration distance.

No = next regeneration must be started manually. (See §6.2 “Manual regeneration start”, page 10)

Servicevalve:

Open = in the event of the message ‘minimum regeneration distance’, the service valve of the saturated filter will remain open until the regeneration start.

Close = in the event of the message ‘minimum regeneration distance’, the service valve of the saturated filter will be closed, causing this filter to no longer supply water.

```

Min. reg. dist.
>Stop                Off
Interval time        4h
Regen.overtake      Yes▼
  
```

```

Min. reg. dist.
Interval time        4h▲
Regen.overtake      Yes
>Servicevalve      Close
  
```

ATTENTION: The option ‘service valve open/closed’ does not exist for duplex filter installations in alternating service, because these switch over to the standby filter.

If there is an attempt to start an automatic regeneration (water meter, time interval, differential pressure meter, analysis device or clock start) before the termination of the entered time, then consequently a message will appear in the LCD display and a signal from the built-in buzzer if such has been programmed under §12.4.2 “Buzzer”, page 41.

If, under §12.1.3 “Outputs”, page 28 a message output has been programmed, in addition a message output can be activated §12.4.3 “Alarm 1”, page 42 and/or §12.4.4 “Alarm 2”, page 42.

12.3.4.3. Capacity exceeded

During the regeneration of a filter of a duplex installation in alternating service or parallel service, one filter still supplies treated water. If however the filter in service becomes saturated as well due to a large extraction and wants to start regenerating, then the message “Capacity exceeded” appears.

Servicevalve:

Closed = if the message ‘capacity exceeded’ appears, the service valve of the filter in service will be closed and the installation will no longer supply water.

Open = service valve remains open until the next regeneration.

```

Cap.exceeded
>Servicevalve      Close
  
```

ATTENTION: If the service valve remains open, it should be guaranteed that the installation can keep supplying softened water up to the start of the regeneration.

The service valve of the saturated filter will stay opened if service valve “**Open**” has been programmed, which may possibly cause the supply of water of a dubious quality.

The service valve of the saturated filter will be closed if service valve “**Close**” has been programmed, which will cause the installation to stop supplying water up to the next regeneration.

12.3.4.4. Input WA

If under § 12.1.2 “Inputs”, page 25 an input has been programmed as “wait”, it is possible to programme whether the service valve should be opened or closed during the message ‘wait during regeneration’. This applies exclusively to a wait signal before the commencement of a regeneration.

Servicevalve:

Closed = in case of the message ‘wait during regeneration’ the service valve of the filter in service will be closed and the installation will no longer supply water.

Open = service valve remains open until the next regeneration.

```
Input WA
>Servicevalve Close
```

ATTENTION: If the service valve remains open, it should be guaranteed that the installation can still supply treated water up to the regeneration.

12.3.4.5. Input CT

If under § 12.1.2 “Inputs”, page 25 an input has been programmed as “chemicals tank”, then it can be programmed whether the service valve should be opened or closed during the message ‘lack of chemicals’. This exclusively applies in the event of a chemicals tank empty signal before a regeneration.

Servicevalve:

Closed = in case of the message ‘lack of chemicals’, the service valve of the filter in service will be closed and the installation will no longer supply water.

Open = service valve stays open until the next regeneration.

```
Input RC
>Servicevalve Close
```

12.3.5. Proportional Brine

When a water meter is connected, you can activate the proportional brine function. Depending on the saturation of the filter the brine time will be calculated.

It is possible, through manual control “**Manual control – Start Compl. Regen.**”, to initiate a complete regeneration also when the filter was not completely exhausted.

```
Regeneration
Start conditions
Stop conditions
>Prop. Brine      Yes
```

When a filter is saturated for 80% at the moment a regeneration was initiated then the actual brine time, fill time and time for chlor production will also be 80% of the programmed time. The time of all other phases will always be 100% of the programmed value.

12.4. Alarms

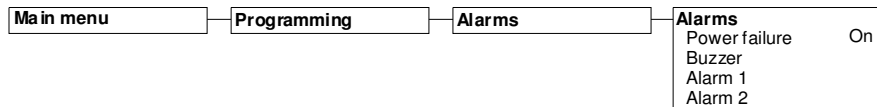

During service and during the regeneration of the installation, various signals that are always shown in the display may occur, and these may be switched to the buzzer or to output 1 and/or 2. This is only possible if under §12.1.3 “Outputs”, page 28 the outputs have been programmed as a message. The following options can be programmed.

12.4.1. Power supply failure

Under power supply failure it is programmed whether, in case of a power interruption, an alarm should be given as soon as the power supply is restored. (See also §12.1.3.5 “Alarm”, page 29)

Power failure:

On = an alarm is given if there has been a power supply failure. **Off** = no alarm is given if there has been a power supply failure.

The screenshot shows the text: **Alarm**
>Power failure On

12.4.2. Buzzer

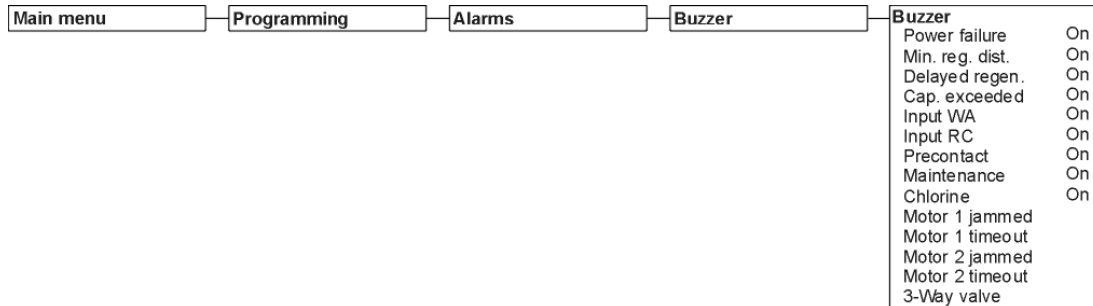

During service and during the regeneration of the installation, various signals may occur, during which the built-in buzzer can be switched on.

Using the “**Menu**” key, it can be programmed whether the buzzer should activate during the relevant alarms.

Signals are possible for:

- *Minimum regeneration distance*, only visible via programming of ‘minimum regeneration distance’ §12.3.4 “Stop conditions”, page 38.
- *Delayed regeneration*, only visible via programming of ‘delayed regeneration’ §12.3.4 “Stop conditions”, page 38.
- *Capacity exceeded*, only visible in the case of duplex installations containing impulse/turbo water meter.
- *Input WA*, only visible via programming of ‘input wait’ under §12.1.2 “Inputs”, page 25.
- *Input CT*, only visible via programming of ‘input lack of chemicals’ under §12.1.2 “Inputs”, page 25.
- *Precontact*, only visible if an impulse/turbo water meter has been programmed. See §12.1.1 “Water meter”, page 23.
- *Maintenance*, only visible if a service interval has been programmed. See §13.5.5 “Maintenance interval”, page 46.
- *Chlorine*, only visible when circuit board IF-FCS3000 is connected and chlorine production is activated. See § 12.1.6 “Chlorine production” on page 31.
- *Motor 1 jammed*, Only programmable when Filter 1 is activated.
- *Motor 1 timeout*, Only programmable when Filter 1 is activated.
- *Motor 2 jammed*, Only programmable when Filter 2 is activated.
- *Motor 2 timeout*, Only programmable when Filter 2 is activated.
- *3-Way valve*, Only programmable when additional circuit board IF-FCS3000 is present.

12.4.3. Alarm 1

Main menu	Programming	Alarms	Alarm 1	Alarm 1	
				Power failure	On
				Min. reg. dist.	On
				Delayed regen.	On
				Cap. exceeded	On
				Input WA	On
				Input RC	On
				Precontact	On
				Maintenance	On
				Chlorine	On

During service and during regeneration of the installation, various signals may occur that can be switched to the built-in alarm output 1, provided that this has been programmed under §12.1.3 “Outputs”, page 28.

ATTENTION: As soon as an alarm situation occurs, output 1 will switch over and a connection between contacts 11-13 will be made. And if there is no alarm situation there will be a connection between contacts 11-12.

Using the “Menu” key, it can be programmed whether the relevant alarms must be connected through to the alarm output or not.

Signals are possible for:

- *Minimum regeneration distance*, only visible via programming of ‘minimum regeneration distance’ §12.3.4 “Stop conditions”, page 38.
- *Delayed regeneration*, only visible via programming of ‘delayed regeneration’ §12.3.4 “Stop conditions”, page 38.
- *Capacity exceeded*, only visible in the case of duplex installations containing impulse/turbo water meter.
- *Input WA*, only visible via programming of ‘input wait’ under §12.1.2 “Inputs”, page 25.
- *Input CT*, only visible via programming of ‘input lack of chemicals’ under §12.1.2 “Inputs”, page 25.
- *Precontact*, only visible if an impulse/turbo water meter has been programmed. See §12.1.1 “Water meter”, page 23.
- *Maintenance*, only visible if no service interval has been programmed. See §13.5.5 “Maintenance interval”, page 46.
- *Chlorine*, only visible when circuit board IF-FCS3000 is connected and chlorine production is activated. See §12.1.6 “Chlorine production” on page 31.

12.4.4. Alarm 2

Main menu	Programming	Alarms	Alarm 2	Alarm 2	
				Power failure	On
				Min. reg. dist.	On
				Delayed regen.	On
				Cap. exceeded	On
				Input WA	On
				Input RC	On
				Precontact	On
				Maintenance	On
				Chlorine	On

During service and during regeneration of the installation, various signals may occur that can be connected to the built-in alarm output 2, provided that this has been programmed under 12.1.3 “Outputs”, page 28.

ATTENTION: As soon as an alarm situation occurs, output 2 will switch over and a connection will be made between contacts 14-16. And if there is no alarm situation there will be a connection between contacts 14-15. Using the “menu” key it can be programmed whether the relevant alarms should be connected through to the alarm output or not.

Signals are possible for:

- *Minimum regeneration distance*, only visible via programming of ‘minimum regeneration distance’ §12.3.4 “Stop conditions”, page 38.
- *Delayed regeneration*, only visible via programming of ‘delayed regeneration’ §12.3.4 “Stop conditions”, page 38.
- *Capacity exceeded*, only visible in the case of duplex installations containing impulse/turbo water meter.
- *Input WA*, only visible via programming of ‘input wait’ under §12.1.2 “Inputs”, page 25.
- *Input CT*, only visible via programming of ‘input lack of chemicals’ under §12.1.2 “Inputs”, page 25.
- *Precontact*, only visible if an impulse/turbo water meter has been programmed. See §12.1.1 “water meter”, page 23.
- *Maintenance*, only visible if no service interval has been programmed. See §13.5.5 “Maintenance interval”, page 46.
- *Chlorine*, only visible when circuit board IF-FCS3000 is connected and chlorine production is activated. See §12.1.6 “Chlorine production” on page 31.

13. Service

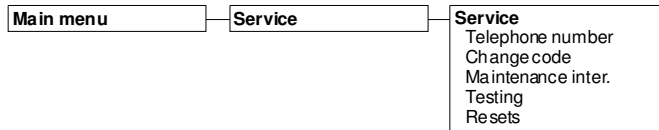

THESE FUNCTIONS MAY EXCLUSIVELY ONLY BE CHANGED BY A WATER TREATMENT EXPERT; INCORRECT USE MAY LEAD TO UNDESIRED MALFUNCTIONS.

The service menu has been screened off by a security code. The manufacturer's security code has been set to "4321". This code can be changed via the menu §13.2 "Change code", page 43.

The cursor can be moved using the "Menu" key and the "Up" and "Down" key is used to change the selected values. Leave the menu using the "Esc" key.

```

Service
Security code           0000
  
```

13.1. Telephone number

Here, the service telephone number provided under Information can be changed.

The cursor can be moved using the "Menu" key and the "Up" and "Down" key is used to change the selected value. Leave the menu using the "Esc" key.

```

Telephone number
+31 12 345 67 89
  
```

13.2. Change code

The safety code can be changed to another code.

The cursor can be moved using the "Menu" key and the "Up" and "Down" key is used to change the selected value. Leave the menu using the "Esc" key.

```

Change code
Security code
Programming           No
  
```

You can also activate the security of the programming menu ("Programming Yes").

ATTENTION: Note down the new code if the standard code is changed.

13.3. Maintenance interval

It can be programmed if there should be a message for maintenance after the production of a certain number of m³ water, after a programmable interval time or after a certain number of regenerations.

```

Maintenance inter.
>Capacity           On
Time               On
Regeneration       On
  
```

Furthermore, a percentage can be entered with regard to a "pre-notification" for the actual maintenance.

13.3.1. Capacity

It can be programmed if there should be a message for maintenance after the production of a certain number of m³ water.

Capacity:

“On”, maintenance interval is activated after a certain production quantity. “Off”, no maintenance interval has been programmed.

Interval:

Production range is from 1 to 650000m³.

```
Capacity
>Capacity           On
Interval           50000m3
```

Before the message is displayed, the amount of water that can yet be produced may be requested via the information menu. (See §8.7 "Maintenance", page 18)

13.3.2. Time

It can be programmed if there should be a message for maintenance after the production of a certain number of m³ water.

Time:

“On”, maintenance interval is activated after a certain interval time. “Off”, no maintenance interval has been programmed.

Interval:

Range is from 1 to 50000 hours.

```
Time
>Time               On
Interval            8000h
```

Before the message is displayed, the remaining time may be requested via the information menu. (See §8.7 "Maintenance", page 18)

13.3.3. Regeneration

It can be programmed if there should be a message for maintenance after a number of regenerations.

Regeneration:

“On”, maintenance interval is activated after a certain number of regenerations. “Off”, no maintenance interval has been programmed.

Interval:

Range is from 1 to 999 regenerations.

```
Regeneration
>Regeneration      On
Interval            300
```

Before the message is displayed, the remaining number of regenerations may be requested via the information menu. (See §8.7 "Maintenance", page 18)

13.3.4. Pre-notification

Prior to the maintenance notification, a so-called “pre-notification” can be given. This entails having to enter a percentage for the maintenance interval.

This percentage is applicable to all maintenance intervals (capacity, time and regenerations).

A percentage of 1-100% can be entered. If the percentage is set to 100%, a pre-notification will not be given.

```
Maintenance inter.
Time               On
Regeneration       On
>Percentage        100%
```



13.4. Testing

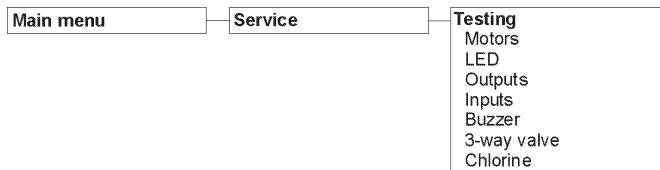

The various components of the controls can be tested separately. The following options can be tested.

13.4.1. Motor test

This function can test whether the CLACK control valve can reach all regeneration phases. If this function is activated, the motor will start running until the piston has reached the regeneration phase 'Rinse' (this is the ultimate position) and then the piston will return to the service position. An alarm will be given if this does not function properly.

```

Motors
>Motion motor 1
Motion motor 2
  
```

ATTENTION: the control valve will pass by all the regeneration phases, and therefore suck up chemicals.

13.4.2. LED check

Select the relevant LED to be tested using the "**Up**" and "**Down**" key, and switch it on/off using the "**Menu**" button. Leave the menu using the "**Esc**" key.

13.4.3. Output check

Select the relevant output to be tested using the "**Up**" and "**Down**" key, and switch it on/off using the "**Menu**" button. Leave the menu using the "**Esc**" key.

ATTENTION: If the control is connected to the installation, it may happen that the valves are being switched. So, be careful while testing the outputs.

13.4.4. Input check

All present inputs are shown in the display. The control will recheck and display the status of the inputs every second. Leave the menu using the "**Esc**" key.

13.4.5. Buzzer check

The buzzer can be switched on/off using the "**Menu**" key. Leave the menu using the "**Esc**" key.

13.4.6. 3-way valve

With the "**Menu**" key you can switch the 3-way valve from filter 1 to filter 2.

Leave this option by pressing the "**Esc**" key. This option is only available when the optional circuit board IF-FCS3000 is present.

13.4.7. Chlorine (current) output

With the "**Menu**" key you can switch the current output for chlorine production between 0, 250 and 500 mA. In the display the current setting will be shown, behind this setting the measured current will be shown.

Leave this option by pressing the "**Esc**" key. This option is only available when the optional circuit board IF-FCS3000 is present.



13.5. Resets

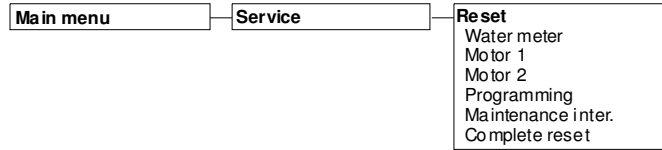

Here, a number of internal counters, the position of the motors, and the programming can be reset. A confirmation will be requested if an option has been selected. This service can be cancelled using the "Esc" key and it can be executed using the "Menu" key.

Esc: Cancel service.
Menu: Execute service.



13.5.1. Water meter

All water counters are set to 0.

13.5.2. Motor 1

THIS FUNCTION LETS THE MOTOR RUN FROM FILTER 1 TO THE SERVICE POSITION. THIS FUNCTION MUST ALWAYS BE EXECUTED AFTER A COMPLETE RESET.

If the CLACK control valve has been disassembled for maintenance, it should always be set back to the service position by using the service function (reset motor 1 and reset motor 2).

13.5.3. Motor 2

Same function as Reset motor 1, but now for motor 2.

13.5.4. Programming

The entire programming of the control is returned to the manufacturer's setting. Counter positions are preserved, however.

13.5.5. Maintenance interval

The counters of the maintenance intervals are set to 0. This should be done after the service activities to the installation have been carried out.

13.5.6. Complete reset

The entire programming and all counter positions will be returned to the manufacturer's settings.

ATTENTION: THE MOTORS MUST ALSO BE RESET SEPERATELY AFTER A COMPLETE RESET, VIA RESET MOTOR 1 AND RESET MOTOR 2. SEE §13.5.2 "MOTOR 1" PAGE 46 AND §13.5.3 "MOTOR 2", PAGE 46.

14. Possible error messages

Various signals are given during the service and the regeneration of the installation, depending on the equipment and programming of the control. These signals can be noticed and will be displayed on the LCD.

These messages can also be programmed onto a message output. See §12.4.3 "Alarm 1", page 42 and §12.4.4 "Alarm 2", page 42)

The buzzer and a possibly activated message output can be switched off via "Menu->Manual Control->Reset alarm".

The LCD information will only be erased if the message signal is no longer active.

14.1. Installation capacity exceeded

This message can only appear in the case of duplex filter installations. While one filter regenerates, the other filter is called for regeneration.

Possible causes:

- activation by the water meter:
 - Incorrect setting of the capacity, the incoming hardness or the water meter.
 - Overloading of the installation, e.g. due to the filling of a large supply tank.
- activation by a water analysis device:
 - Hardening of a new installation that has been taken into service, caused by a counter ion effect.
Solution: building in of a rinse valve or circulation pump. Reduce the sensitivity of the analysis device.
- other causes:
 - Inadequate regeneration of the filter, for instance due to lacking or non-absorbed regeneration substances.

**Message
Capacity
exceeded**

ATTENTION: After termination of the regeneration that is being carried out, the other filter will be regenerated automatically.

In the case of external activation of the regeneration, for instance by a water analysis device, the regeneration of the second filter is not, however started, since it can be assumed that the hardness message has been given based on the so called counter ion effect of the filter that was in the spare position. The second filter will only be regenerated if the relevant start signal is given again after the completion of the current regeneration. If, in the case of ion exchangers with a brine production tank, no brine has been produced for the second filter, then the regeneration needs to be delayed again.

14.2. Power supply failure

No data will be lost during a power supply failure. If the installation is again provided with power, the control will be in the same position and contain the same values as before the power interruption.

**Message
Supply failure**

ATTENTION: If the installation is in a regeneration position during a power supply failure, then this may cause a saturation of the filter due to endless rinsing, provided that the water pressure was preserved during all that time. If necessary, terminate the regeneration and start it again after the chemicals supply has been checked.

14.3. Chemicals low

The chemicals supply tank is empty, refill the regeneration substance.

ATTENTION: A planned regeneration will only be executed if there are either regeneration substances available again or if a manual start is carried out via "Main menu->Manual Control ->Start regeneration".

In the case of duplex filter installations connected in series, there is however a switch over to the filter that is in the spare position. This message only appears if an input has been programmed as chemicals tank under §12.1.2.1 "chemicals tank", page 25.

**Message
Chemicals low**

14.4. Delayed regeneration

This message only appears if the activation for delayed regeneration has been programmed under §12.3.4 "Stop conditionss", page 38.

The status of the filter and the time at which regeneration is permitted again are displayed alternately on the message screen.

**Message
Delayed
regeneration**

The desired regeneration will only start at the time shown on the LCD.

E.g. Wednesday at 8:00 hours.

Nevertheless, a regeneration can be started via "Main menu->Manual Control->Start regeneration".

**Filter 2 Wait for
Regen. We.08:00

Sat.12:00 01/01/2005**

14.5. Waiting during regeneration

This message may have various causes, depending on the function of the connected switch contact, for example: mutual locking of two controls or a drop in control pressure in the case of pneumatic valves.

Establish the cause and solve the problem.

The situation "Waiting for regeneration" is activated if the input "Waiting during regeneration" is already active during the start of the regeneration. In the case of exchange connection there will also be a switch to the spare filter.

**Message
Wait during
regeneration**

ATTENTION: The waiting signal can be cancelled for the duration of the regeneration via "Main menu ->Manual Control->Start regeneration". The regeneration is continued.

14.6. Minimum regeneration distance

Possible cause in the case of activation by the water meter:

- Incorrect setting of the capacity, the incoming hardness or the water meter.
- Overloading of the installation, e.g. caused by filling of a large tank.

**Message
Minimum regeneration
distance**

Possible causes in the case of external activation by a water analysis device:

- Hardening of a new installation that is put into service, caused by a counter ion effect.
Solution: building in of a rinse valve or circulation pump. Reduce sensitivity of the analysis device.

ATTENTION: It can be programmed under §12.3.4 "Stop conditions", page 38, "minimum regeneration distance->Regeneration catch up" whether a regeneration is started immediately after passing of the "minimum regeneration distance", or whether the next regeneration should be activated manually.

ATTENTION: The message on the LCD only disappears after a regeneration start.

14.7. Precontact

This message only appears if under §12.3.3 "Start conditions", page 36, "Water meter->Precontact" the precontact has been programmed.

It is not possible to switch off the message contact manually if "Precontact"->"Start regeneration" has been programmed on "Off".

This ensures that the water analysis device connected it is not switched off prematurely.

If "Precontact"->"start regeneration" has been programmed to "On", it is however possible to switch off the message output.

As soon as a regeneration is started, the display and the output are switched off automatically.



**Message
Precontact**

14.8. Maintenance interval

This message only appears if a maintenance was entered. The buzzer and the possibly programmed message output can be reset via "Main menu->Manual Control->Reset".

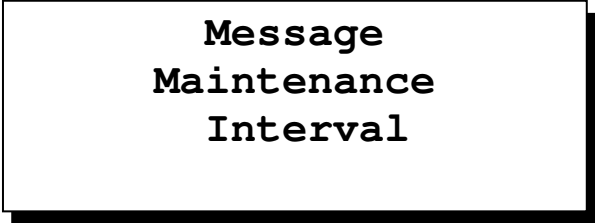

**Message
Maintenance
Interval**

If a pre-notification has been set it will be given prior to the maintenance notification.
(see § 13.3.4 "Pre-notification" on page 44).

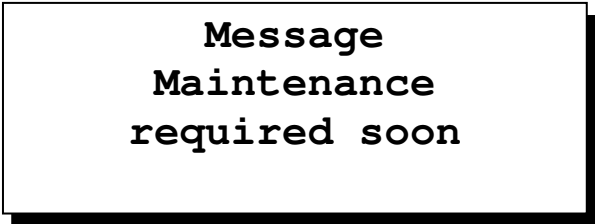

**Message
Maintenance
required soon**

Contact the maintenance company to carry out periodic maintenance. The relevant LCD can only be reset by the authorized maintenance company.

14.9. Motor 1

This message appears if the motor of filter 1 has been jammed.

Possible cause:

- The control valve has just been serviced, but the motor has not yet been put back into service position. Carry out a reset of the motor. (§13.5.2 “Motor 1”, page 46.)
- There is dirt in the control valve, clean the control valve and let the motor run to the service position.
- The motor has been placed incorrectly or the wiring has been interrupted, check the motor and the wiring.
- Gear system is damaged, check the gear box.
- PCB is damaged or has been connected incorrectly, replace the PCB and check the wiring.
- Control valve has not been assembled properly, check the control valve.

**Message
Motor 1
jammed**

14.10. Motor 2

This message appears if the motor of filter 2 has been jammed.

Possible cause:

- The control valve has just been serviced, but the motor has not yet been put back into service position. Carry out a reset of the motor. (§13.5.3 “Motor 2”, page 46.)
- There is dirt in the control valve, clean the control valve and let the motor run to the service position.
- The motor has been placed incorrectly or the wiring has been interrupted, check the motor and the wiring.
- Gear system is damaged, check the gear box.
- PCB is damaged or has been connected incorrectly, replace the PCB and check the wiring.
- Tracer head has been assembled incorrectly, check the control valve.

**Message
Motor 2
jammed**

14.11. Motor 1 time exceeded

This message appears when motor 1 takes too much time to attain its new position.

- There is dirt in the control valve, clean the control valve and let the motor run to the service position.
- The motor has been placed incorrectly or the wiring has been interrupted, check the motor and the wiring.
- Gear system is damaged, check the gear box.
- PCB is damaged or has been connected incorrectly, replace the PCB and check the wiring.
- Tracer head has been assembled incorrectly, check the control valve.

**Message
Motor 1 time to
attain next position
exceeded**



14.12. Motor 2 time exceeded

This message appears when motor 2 takes too much time to attain its new position.

- There is dirt in the control valve, clean the control valve and let the motor run to the service position.
- The motor has been placed incorrectly or the wiring has been interrupted, check the motor and the wiring.
- Gear system is damaged, check the gear box.
- PCB is damaged or has been connected incorrectly, replace the PCB and check the wiring.
- Tracer head has been assembled incorrectly, check the control valve.

Message
Motor 2 time to
attain next position
exceeded

14.13. Chlorine production

This message appears only when optional circuit board IF-FCS3000 is present and the function for chlorine production is activated.

This message appears when the measured current is corresponding to the current setting.

Message
Chlorine current

Through "**Main menu – Manual control -Reset**" the buzzer and (when programmed) alarm relays can be deactivated.



15. Frequently asked questions

Question:

The regeneration process is improperly executed electrically and/or mechanically.

Answer:

- The motor was not in home position at the start of the regeneration. Stop the regeneration and reset the relevant motor so that the motor runs into the home position. Then start the regeneration again.

Question:

The order of the regeneration steps is not carried out properly.

Answer:

- The programming of the regeneration process is incorrect, check this under §12.3.2 "Regeneration", page 34.

- The motor was not in home position at the start of the regeneration. Stop the regeneration and reset the relevant motor so that the motor runs into the home position. Then start the regeneration again.

16. Overview menu

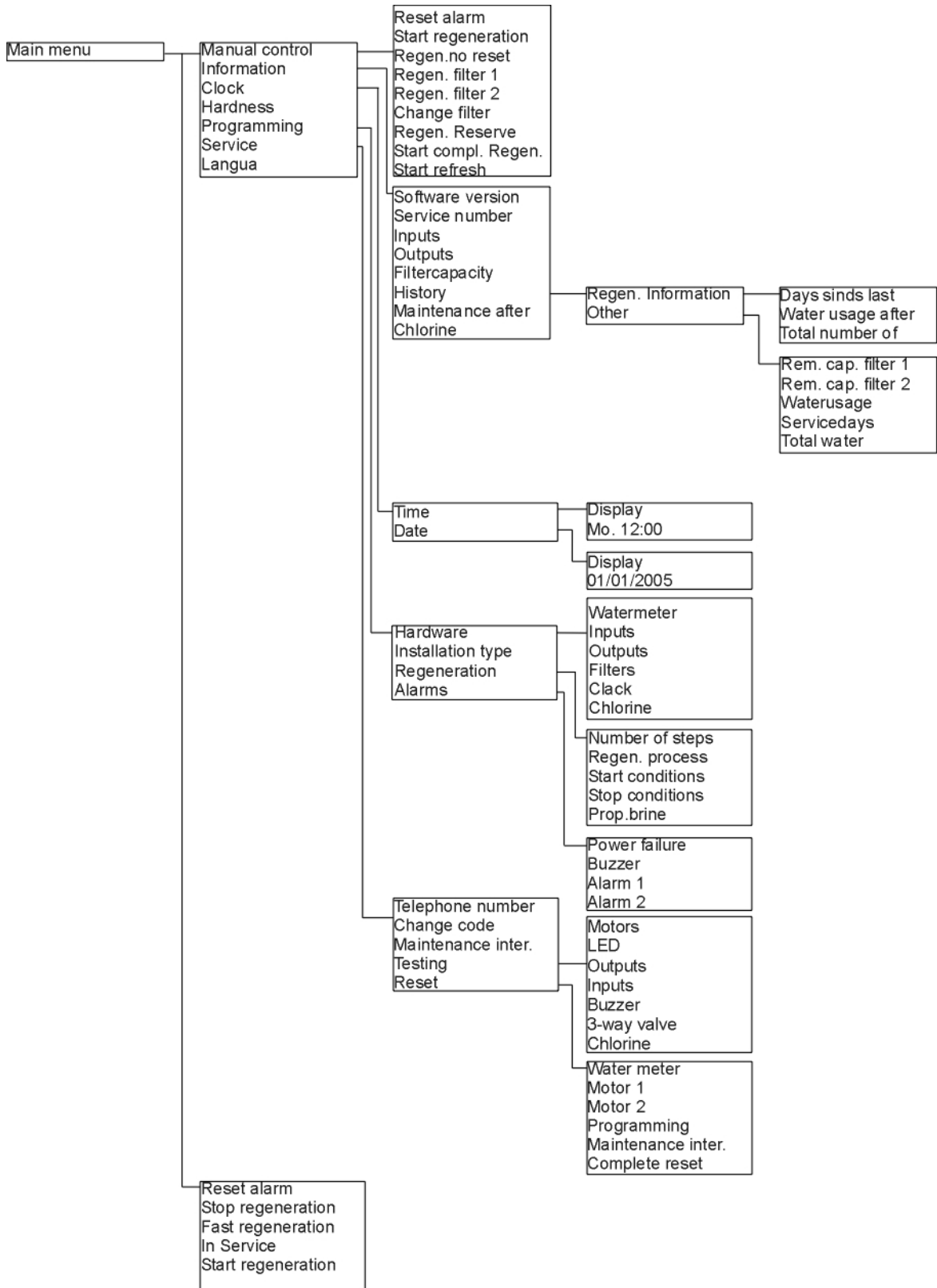

17. Opening of housing

Remove both side covers of the housing.

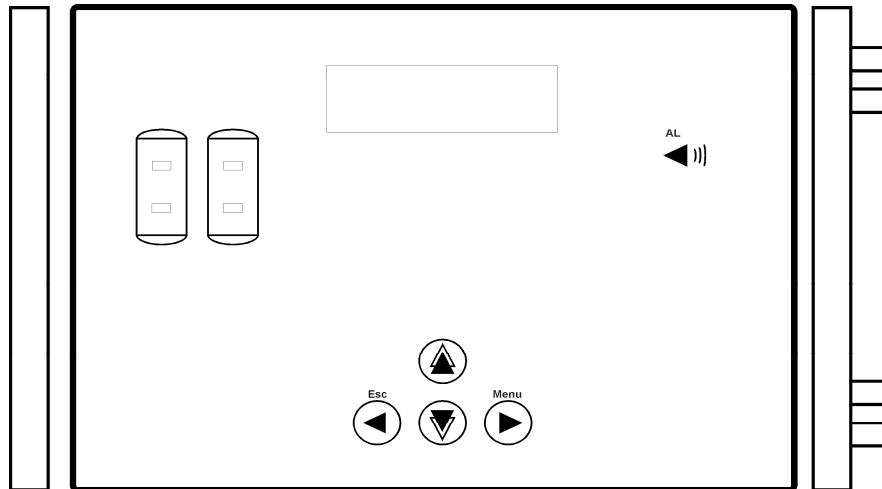

Open the housing on the left by placing the key cover carefully between the hinge points and pushing it through until the front cover opens up.

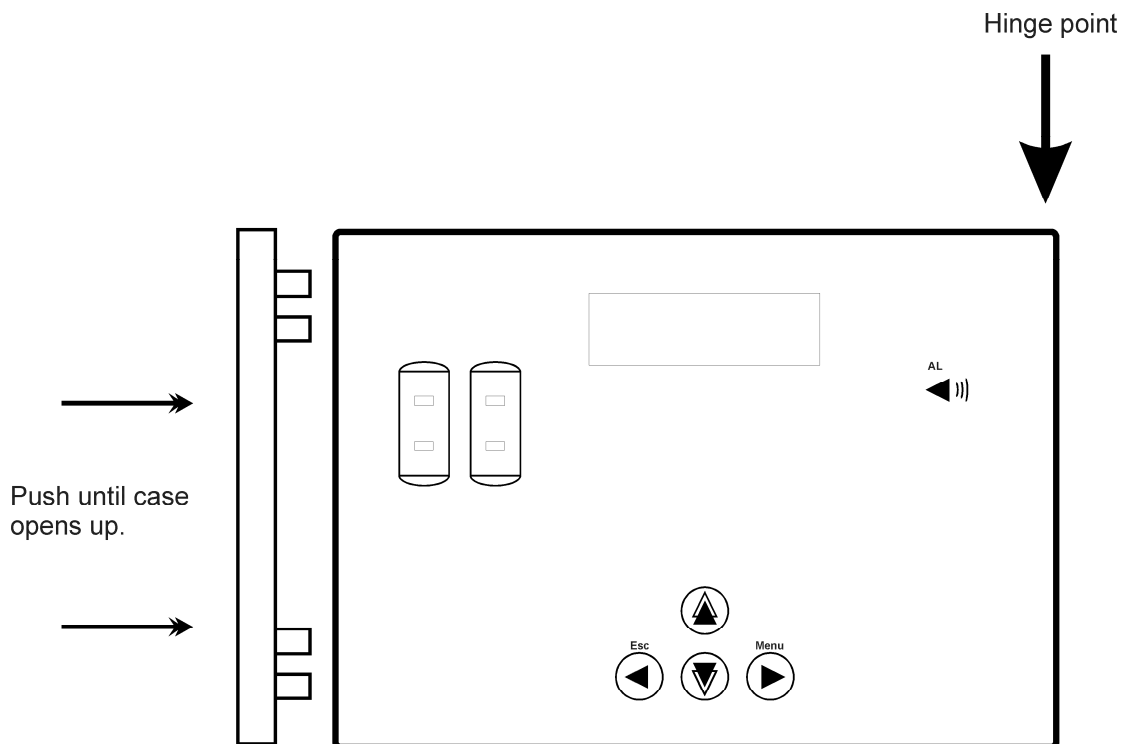

18. Connection diagram FCS3000

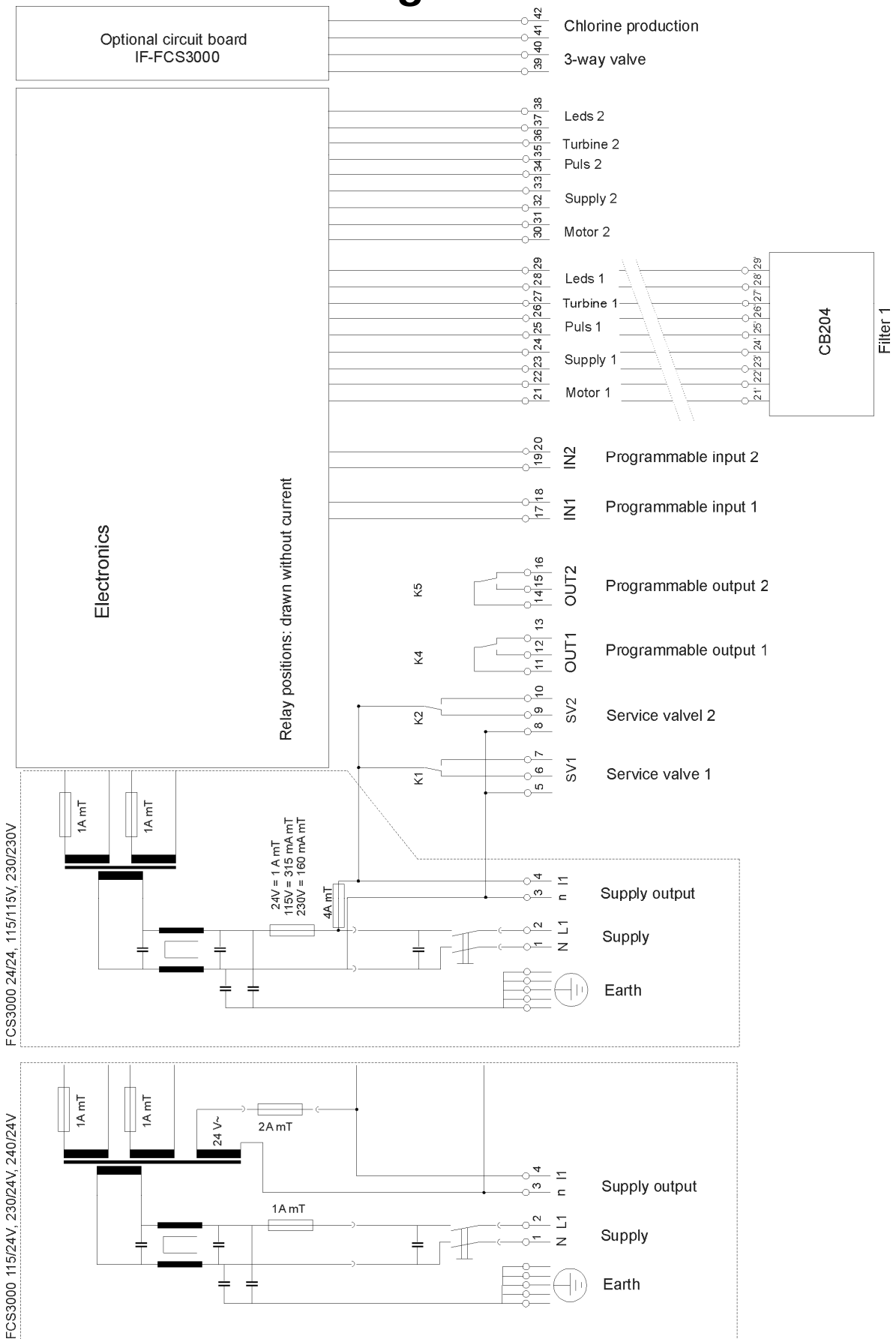

See the glossary on the next page.



18.1. Glossary

SV1	Connection for the service valve of filter 1. Power conducting.
SV2	Connection for the service valve of filter 2. Power conducting.
OUT1	Programmable potential free output. <i>Options:</i> <ul style="list-style-type: none">- Alarm, No alarm: contact between 11, 12. Alarm situation: contact between 11, 13- Feed pump- Additional program- Regeneration
OUT2	Programmable potential free output. <i>Options:</i> <ul style="list-style-type: none">- Alarm, No alarm contact between 14,15. Alarm situation: contact between 14,16- Feed pump- Additional program- Regeneration
IN1	Programmable input 1. <i>Options:</i> <ul style="list-style-type: none">- Chemicals tank- Wait- Regeneration start- Level switch, (high level)- Impulse water meter
IN2	Programmable input 2. <i>Options:</i> <ul style="list-style-type: none">- Chemicals tank- Wait- Regeneration start- Level switch, (low level)- Impulse water meter

Connections between Filter 1 and CB204

Motor 1	Addressing of motor 1.
Voeding 1	Power supply.
Puls 1	Pulse counter for motor 1.
Turbine 1	Turbo water meter of filter 1.
LEDs 1	LEDs of filter 1. Service and regeneration LED.

Connections between Filter 2 and CB204

Motor 2	Addressing of motor 2.
Voeding 2	Power supply.
Puls 2	Pulse counter for motor 2.
Turbine 2	Turbo water meter of filter 2.
LEDs 2	LEDs of filter 2. Service and regeneration LED.

19. Electrical connection examples

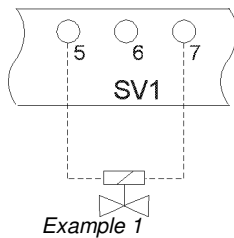

Connection of a magnet valve that opens if it is live, to:

- Connection SV1 : terminals 5 and 7
- Connection SV2 : terminals 8 and 10

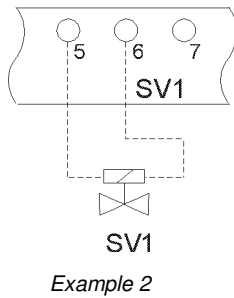

Connection of a magnet valve that closes if it is live, to:

- Connection SV1 : terminals 5 and 6
- Connection SV2 : terminals 8 and 9

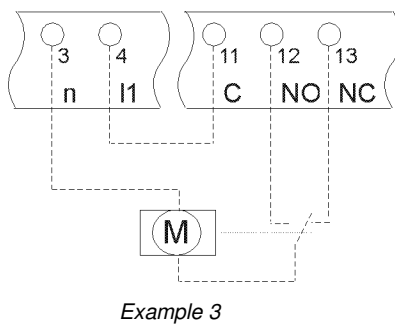

Connection of an motor driven valve to a potential free output:

- Connection OUT1 : terminals 3, 12 and 13
Bridge from 4 to 11
- Connection OUT2 : terminals 3, 15 en 16
Bridge from 4 to 14

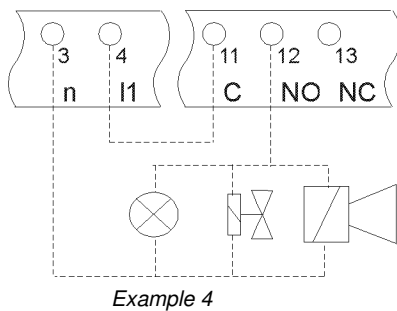

Connection of a signalling lamp, horn or a magnet valve that is active when it is live, to a potential free output:

- Connection OUT1 : terminals 3 and 12
Bridge from 4 to 11
- Connection OUT2 : terminals 3 and 15
Bridge from 4 to 14

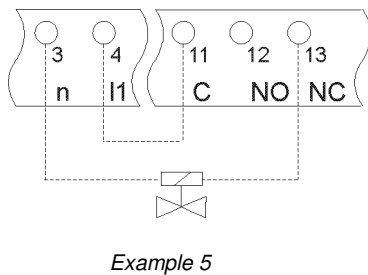

Connection of a magnet valve that is inactive when it is live, to a potential free output:

- Connection OUT1 : terminals 3 and 13
Bridge from 4 to 11
- Connection OUT2 : terminals 3 and 16
Bridge from 4 to 14



20. Installation and start-up regulations

General

Installation and commissioning of the control system may only be carried out by trained specialists who are familiar with these operating instructions and the applicable regulations on safe working practices and accident prevention. The instructions given in this manual must always be observed and followed.

To guarantee functional operation and safety, the instructions in this manual must be followed. The manufacturer accepts no liability for damage resulting from failure to follow the instructions.

Assembly

- Do not install under damp pipes. Fit shielding if necessary.
- Insert the flush-fit unit into the 186x138 panel opening and secure using the corresponding clamps and sealing ring.
- Install device at eye level and easily accessible to the user.

Connection

- Before carrying out connection work, always ensure the control unit is first disconnected from the power supply. Make sure that the power supply remains disconnected during connection work.
- Make electrical connections. Observe local regulations.
Connect supply voltage and ground to the terminals shown in the wiring diagram.
- Make sure that the ground connection is faultless.
- The front panel is connected to ground via a plug connection which must not become disconnected during operation.
- If possible, keep all extra low voltage cabling (digital inputs, measurements) separate from the power supply cable.
- It is not permitted to connect the potential-free relays with a combination of 230 VAC and extra low voltage.
- The flush-fit unit is supplied without main switch. Install this main switch in the switch cabinet yourself.
- Some external relays, magnetic switches, solenoid valves, etc. can cause unwanted interference pulses when switched off.
For this reason, it is recommended that the components mentioned should be equipped with a so-called RC network in advance.
Ask the supplier of the mentioned components for the correct type of RC network.

Commissioning

- Let the motors run to home position. (§13.5.2 "Motor 1", page 46 and § 13.5.3 "Motor 2", page 46.)
- Keep front lid closed at all times
- The control system may only be switched on if it is completely closed and all connections have been made correctly.



21. Maintenance

The control system does not contain any user-serviceable parts. Unauthorised modifications and/or repairs to the control unit will void all warranty claims and the manufacturer's liability.



22. Spare components

The complete FCS3000-C consists of:

Number	Article number	Description
1	FCS3000, voltage.	Control is available in the following voltages: - 240V / 24V - 230V / 24V - 115V / 24V - 230V / 230V - 115V / 115V - 24V / 24V
2	CB204.	Connection board for the control valves.
1	Membrane FCS3-1.	Foil for the control valve featuring the text Filter 1.
1	Membrane FCS3-2.	Foil for the control valve featuring the text Filter 2.

22.1. Connecting cable

The connection between the control and the CB204 prints must be realised using a low voltage cable of the type: LIYY 10x0, 14mm². This is a standard low voltage cable that can be obtained through most wholesalers.

23. Technical data



Mains connection:	24V	± 10% 50-60 Hz Mains fuse 1AT
	115V	± 10% 50-60 Hz Mains fuse 315mAT
	230V	± 10% 50-60 Hz Mains fuse 160mAT
	115/24V	± 10% 50-60 Hz Mains fuse 1AT
	230/24V	± 10% 50-60 Hz Mains fuse 1AT
	240/24V	± 10% 50-60 Hz Mains fuse 1AT
Power input:	11VA	
Voltage conducting outputs:	Loadable total up to 2A at 115/24V, 230/24V and 240/24V. And loadable total up to 4A at 24V/24V, 115V/115V, 230V/230V	
Potential free output:	max. load 250V, 4A, if input voltage is equal to output voltage. max. load 250V, 2A, at an output voltage of 24V.	
Inputs:	loaded with 12V, 18 mA	
Protection classification:	IP65	
Environmental temperature:	0 – 40 °C	
Weight:	approx 2.5 kg	
Dimensions:	W x H x D = 252 x 186 x 110 mm	
Details:	Data remain stored in case of power interruption.	

23.1. Housing dimensions

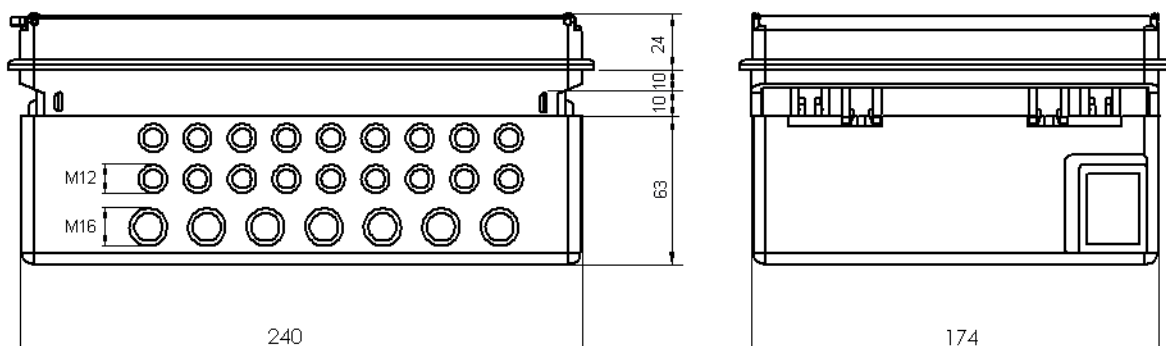

Unit of measurement: mm.



24. Declaration of conformity

Declaration of conformity of the product with the essential requirement of the EMC directive 89 / 336 / EEC.

Product description

Product name : Controller for water softening installation
Product type : FCS3000
Manufacturer : EWS Equipment for Water treatment Systems International B.V.
Australiëlaan 12
NL-5232 BB 's-Hertogenbosch
The Netherlands

Product environment

This product is intended for use in residential en light industrial environments.

Emission standard : EN 61000-6-3, EN 55022
Immunity standard : EN 61000-6-1, EN 61000-6-2
Low voltage directive : 2006/95/EG

Report

Report number : EWS / EMC / FCS3000

This declaration was issued by:

Date : 11-03-2020

Name : V. Naeber

Signature :



FIVE-YEAR CONTROLLER LIMITED WARRANTY

LIMITED WARRANTY

EWS International (hereafter EWS) warrants her products free from defects in material and workmanship under the following terms.

In this warranty, "Products" shall be taken to mean all devices that are supplied pursuant to the contract with exception of software.

VALIDITY OF THE WARRANTY

Labour and parts are warranted for five years from the date of the first customer purchase. This warranty is only valid for the first purchase customer.

Notwithstanding the warranty period of five years as mentioned above - while upholding the remaining provisions – a warranty period of three months applies to the supply of software.

COVER OF THE WARRANTY

Subject to the exceptions as laid down below, this warranty covers all defects in material or workmanship in the EWS products. The following are not covered by the warranty:

- 1) Any product or part not manufactured nor distributed by EWS. EWS will pass on warranty given by the actual manufacturer of products or parts that EWS uses in the product.
- 2) Any product, on which the serial number has been defaced, modified or removed.
- 3) Damage, deterioration or malfunction resulting from:
 - a) Accident, misuse, neglect, fire, water, lightning or other acts of nature.
 - b) Product modification or failure to follow instructions supplied by the products.
 - c) Repair or attempted repair by anyone not authorized by EWS.
 - d) Any shipment of the product (claims must be presented to the carrier)
 - e) Removal or installation of the product
 - f) Any other cause, which does not relate to a product defect.
 - g) Cartons, equipment enclosures, cables or accessories uses in conjunction with the product.

FINANCIAL CONSEQUENTES

EWS will only pay for labour and material expenses for covered items, proceed from repairs and updates done by EWS at the EWS location. EWS will not pay for the following:

- 1) Removal or installations charges at customers and/or end user location.
- 2) Costs for initial technical adjustments (set-up), including adjustment of user controls or programming.
- 3) Shipping charges proceed from returning goods by the customer. (Shipping charges for returning goods to the customer are for the account of EWS).

All the costs which exceed the obligations of EWS under this Warranty, such as, but not limited to, travel and accommodation costs and costs for assembly and dismantling are for the account and risk of the customer.

WARRANTY SERVICE

In order to retain the right to have a defect remedied under this warranty, the customer is obliged to:

- 1) Submit complaints about immediately obvious errors related to the products delivered, in writing within eight days of the delivery of the products and submit complaints about shortcomings relating to the products delivered, which are not visible, within eight days of their being discovered.
- 2) Return defected products for account and risk of the customer. Costs for this shipment will not be reimbursed by EWS. The products may only be returned following express, written permission from EWS. Returning the products does not affect the obligation to pay the invoiced amounts.



- 3) Present the original dated invoice (or a copy) as proof of warranty coverage, which must be included in any [of the] return shipment of the product. Please include also in any mailing a contact name, company, address and a description of the problem(s).

LIMITATION OF IMPLIED WARRANTIES

Except where such disclaimers and exclusions are specifically prohibited by applicable law, the foregoing sets forth the only warranty applicable to the product, and such warranty is given expressly and in lieu of all other warranties, express or implied, or merchantability and fitness for a particular purpose and all such implied warranties which exceed or differ from the warranty set forth herein are hereby disclaimed by EWS.

EXCLUSION OF DAMAGES

EWS' liability for any defective products is limited to the repair or replacement of the product at our option. Except where such limitations and exclusions are specifically prohibited by applicable law EWS shall not be liable for:

- 1) Damage to other property caused by defects in the EWS product, damages based upon inconvenience, loss of use of the product, loss of time, commercial loss or:
- 2) Any damages, whether incidental, [consequential or otherwise] special, indirect or consequential damages, injury to persons or property, or any other loss.

Under no circumstances whatsoever shall EWS be obliged to provide compensation beyond the direct damage incurred by customer up to an amount not exceeding the payment receivable from the insurer of EWS in connection with the damage.

APPLICABLE LAW AND DISPUTES

- 1) Dutch law shall govern all offers made by EWS and all agreements concluded between EWS and customer. This warranty explicitly excludes application of the Vienna Sales Convention (CISG).
- 2) All disputes which may arise between the parties shall be dealt with exclusively by the competent court of law in the Netherlands under whose jurisdiction EWS falls. However, EWS reserves the right to submit any disputes to the competent court in the customer's location.