

UF2050

Control for ultra filtration installations



Instruction manual

Software version 1.00

Contents

1. General description	1
1.1. General	1
1.2. List of abbreviations used	1
1.3. Overview of phases	2
1.4. Phase "Standby"	2
1.5. Phase "Filtration"	2
1.6. Phase "Pre Flush"	3
1.7. Phase "Air scour"	3
1.8. Phase "Flush 1"	3
1.9. Phase "Back wash"	3
1.10. Phase "Enhanced Back wash 1"	4
1.11. Phase "Enhanced Back wash 2"	4
1.12. Phase "Flush 2"	4
1.13. Phase "Alarm"	4
2. Picture front side	5
3. Function display	6
3.1. LED Display	6
3.2. LED displays	6
3.3. LCD display	6
3.3.1. Display during "Filtration"	6
3.3.2. Display during "Standby"	7
3.3.3. Display during "Alarm"	7
4. Input functions	8
4.1. High level clean water tank	8
4.2. Low level clean water tank	8
4.3. Low level raw water tank	8
4.4. Overpressure	8
5. Output functions	9
5.1. General output	9
5.2. Alarm	9
6. General control	9
6.1. Main screen	9
6.2. Menus	9
7. Manual mode of the installation	10
7.1. Manually start backwash	10
7.2. Manually start "Enhanced backwash 1"	10
7.3. Manually start "Enhanced backwash 2" without reset	10
7.4. Manually start "Enhanced backwash 2" with reset	10
7.5. Reset alarm	10
8. Information request	11
8.1. Status inputs	11
8.2. Status outputs	11
8.3. Service number	11
8.4. Software version	11
8.5. Enhanced back wash interval	11
9. Change set language	12
10. Programming	13
10.1. Output functions	13

10.2	Input functions.....	13
10.3	Process steps.....	14
10.4	Power up settings.....	16
10.5	Alarm output.....	16
11	Possible error messages.....	17
11.1	Power failure	17
12	Wiring diagram UF2050	18
13	Installation and commissioning requirements.....	19
13.1	General.....	19
13.2	Assembly.....	19
14	Technical details	20
15	Declaration of conformity.....	21
	APPLICABLE LAW AND DISPUTES.....	23



1. General description

1.1. General

The UF2050 is used for the automatic control and monitoring of ultra filtration installations.

The flexible, programmable software makes this control suitable for a large number of different applications in the field of water treatment.

Overview of functionality

- Menu-driven operating and programming of the control by means of keys and a 2-line display.
- Choice of language. (i.e. Dutch, English, German).
- Universally applicable to ultra filtration installations.
- Flexibly programmable for specific user requirements.
- Free programmable service phone number.
- Inputs:
 - low level clean water tank / high level clean water tank ,
 - low level raw water tank and exceeded pressure
- Outputs:
 - programmable for individual valves and central control valves
 - suction valve cation, suction valve anion, rinsing valve, refuelling valve cation, refuelling valve anion, flow pulse, circulation pump, regeneration, alarm
- Voltage drop-out protection program information, program information is saved without battery
- Produced according to EMC directives
- Housing suitable for wall mounting
- Available in 24/24V, 115/115V, 230/230V, 115/24V, 230/24V, 240/24V

1.2. List of abbreviations used

Herewith a list of frequently used abbreviations

STB	Stand by	HL	High level switch clean water tank
PFL	Pre Flush	LL	Low level switch clean water tank
FIL	Filtration	RW	Low level switch raw water tank
AIR	Air scour	OP	Over pressure switch
FL1	Flush 1		
BW	Back wash	AL	Alarm output
BWE1	Enhanced Back wash 1	OUT	General output
BWE2	Enhanced Back wash 2		
FL2	Flush 2		



1.3 Overview of phases

The control distinguishes different phases:

- | | |
|-----------------------|--|
| - Stand by | Installation is switched off so no water is produced |
| - Pre flush | Flushing before going from standby to filtration |
| - Filtration | Filtration in progress |
| - Flush 1 | Flush before back wash |
| - Backwash | Back wash |
| - Enhanced Backwash 1 | Back wash with acid |
| - Enhanced Backwash 2 | Back wash with alkaline |
| - Flush 2 | Flush after back wash |

When the enhanced backwashes are activated (step 3.2, BWE) the controller will count the number of "normal" backwashes. After a programmed number of "normal" back washes (step 3.3), the enhanced back wash cycle will be initiated in two cycles.

After the filtration time has passed the normal sequence will be followed with an additional (enhanced) back wash directly after the "normal" back wash phase. First it will be "Enhanced back wash 1". In the next back wash cycle it will be "Enhanced back wash 2".

Normal sequence for back wash :

Filtration – Air scour – Flush 1 – Back wash – Flush 2

Sequence for enhanced back wash 1

Filtration – Air scour – Flush 1 – Back wash – Enhanced backwash 1 - Flush 2

Sequence for enhanced back wash 2

Filtration – Air scour – Flush 1 – Back wash – Enhanced backwash 2 - Flush 2

When a phase is not activated (step 3.1) this step will be skipped.

Attention !

If a low level in the clean water tank is detected, all output as programmed in step 2.4 are switch off. So when this input (RC) is activated the state of the outputs could differ from the state as programmed for the actual phase.

1.4 Phase "Standby"

During standby the low level (RW tank) and high level (CW tank) will be checked. When both are not activated the installation will switch to "Pre flush" (if activated in step 3.1) and then to "Filtration".

All outputs free programmable.

The following values are monitored:

- Low level, raw water tank
- High level, clean water tank

It is also possible to start the phase "Back wash" or one of the enhanced back washes, manually.

The enhanced backwashes should be activated (see § 10.3 "Process steps" on page 14).

For more information about the manual control see § 7 "Manual mode of the installation" on page 10.

1.5 Phase "Filtration"

During filtration the low level (RW tank) and high level (CW tank) will be checked. When one or both are activated the installation will switch to standby.

After a programmed interval time the installation will switch to "Flush1" (if activated in step 3.1).

All outputs free programmable.

The following values are monitored:

- Overpressure
- Low level, raw water tank
- High level, clean water tank



1.6 Phase “Pre Flush”

This step has to be activated in step 3.1 (PFL).

The step “Pre flush” will be activated after switching power on (when program step 4.1 is programmed for ‘PFL’) or when the installation will go to the “Filtration” step after “Standby”.

After a programmed time the installation will go into “Filtration”.

All outputs free programmable.

The following values are monitored:

- Overpressure

1.7 Phase “Air scour”

This step has to be activated in step 3.1 (AIR).

The installation will switch to “Air scour” after the “Filtration” time has passed.

You can also start “Air scour” manually by pressing the  key during “Standby” or “Filtration”.

After a programmed time the installation will switch to “Flush 1”.

All outputs free programmable.

The following values are monitored:

- Overpressure

1.8 Phase “Flush 1”

This step has to be activated in step 3.1 (FL1).

The installation will switch to “Flush 1” after the “Filtration” time has passed.

You can also start “Flush 1” manually by pressing the  key during “Standby” or “Filtration”.

After a programmed time the installation will switch to “Backwash”.

All outputs free programmable.

The following values are monitored:

- Overpressure

1.9 Phase “Back wash”

The installation will switch to “Backwash” after the “Air scour” or “Flush 1” time has passed.

After a programmed time the installation will switch to “Flush 2”, “Enhanced Back wash 1” or “Enhanced Back wash 2”.

All outputs free programmable.

The following values are monitored:

- Overpressure



1.10 Phase “Enhanced Back wash 1”

This step has to be activated in step 3.2 (BWE).

The installation will switch to “Enhanced Backwash 1” after the “Back wash” time has passed and the programmed number (step 3.3) of “normal” back washes has been reached.

When the next filtration time has passed “Enhanced Back wash 2” will be initiated.

See also § 1.3 “Overview of phases” on page 2.

After a programmed time the installation will switch to “Flush 2”.

The remaining number of backwashes until the enhanced back wash cycle can be checked in the information display (see § 8.5 “Enhanced back wash interval” on page 11).

All outputs free programmable.

The following values are monitored:

- Overpressure

1.11 Phase “Enhanced Back wash 2”

This step has to be activated in step 3.2 (BWE).

The installation will switch to “Enhanced Backwash 1” after the “Back wash” time has passed, the programmed number (step 3.3) of “normal” back washes has been reached and “enhanced backwash 1” cycle has been made. See also § 1.3 “Overview of phases” on page 2.

After a programmed time the installation will switch to “Flush 2”.

The remaining number of backwashes until the enhanced back wash cycle can be checked in the information display (see § 8.5 “Enhanced back wash interval” on page 11).

All outputs free programmable.

The following values are monitored:

- Overpressure

1.12 Phase “Flush 2”

This step has to be activated in step 3.1 (FL2).

The installation will switch to “Flush 2” after the “Back wash” time has passed.

After a programmed time the installation will switch to “Filtration” or “Standby” (depending on the state of the level switches).

All outputs free programmable.

The following values are monitored:

- Overpressure

1.13 Phase “Alarm”

The installation will switch to “Alarm” when there is a overpressure situation or when program step 4.1 is programmed at “AL”.

During alarm the over pressure switch and the  key will be checked.

When pressing the key and the pressure is ok, the installation will proceed the process step that was interrupted. The interval time for the flush and back wash steps will also proceed and not be reset.

All outputs will be deactivated.

The following values are monitored:

- Overpressure

2 Picture front side

Wall mounting

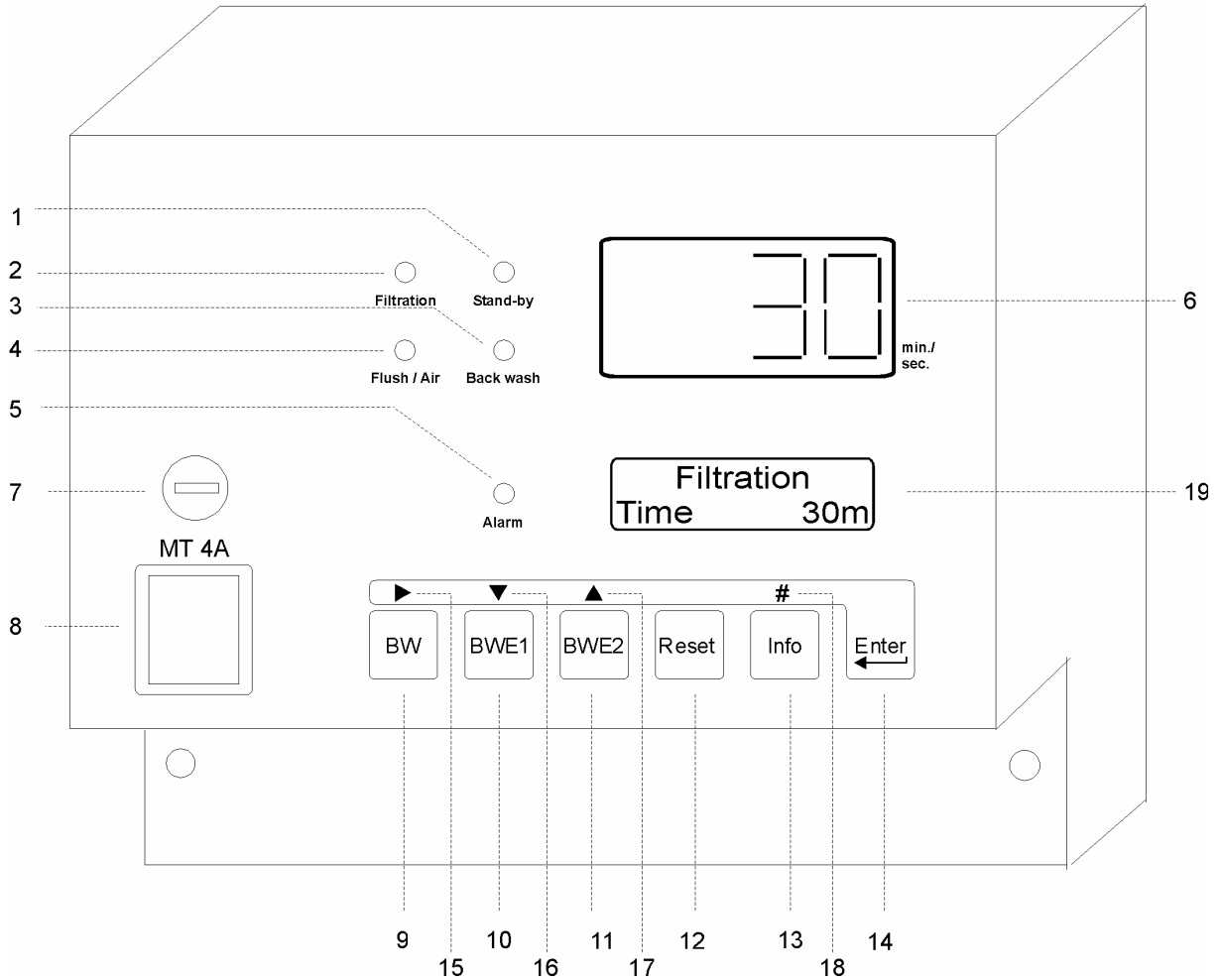

- | | | | |
|---------------------|----------------------------|-----------------------|-----------------|
| 1. LED "Standby" | 7. Fuse for output power | 13. Info | 19. LCD display |
| 2. LED "Filtration" | 8. Main switch | 14. Programming | |
| 3. LED "Backwash" | 9. Start Back wash | 15. Move cursor | |
| 4. LED "Flush" | 10. Start Enhanced Backw 1 | 16. Next program step | |
| 5. LED alarm | 11. Start Enhanced Backw 2 | 17. Last program step | |
| 6. LED display | 12. Reset | 18. Digital input | |

3 Function display

3.1 LED Display

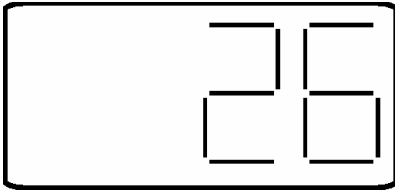

In the LED display the remaining time for the current process phase will be displayed.

When the message “----” appears in the display, it means that there is no timer activated. This will be the case in the phases “Stand-by” or “Alarm”.

3.2 LED displays

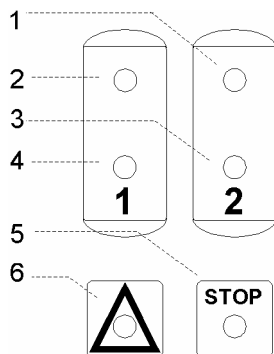

- 1 = LED for phase “Stand by”
- 2 = LED for phase “Filtration”
- 3 = LED for phase “Back wash”
 - (continuous) = normal back wash
 - (blinking) = “Enh. Back wash 1” or “Enh. Back wash 2”
- 4 = LED for Flush phases / Air scour
 - (continuous) = “Pre Flush” / “Flush 1” or “Flush 2”
 - (blinking) = “Air scour”
- 5 = Not used
- 6 = Alarm

3.3 LCD display

In the first line of the LCD display the actual status of the installation is always displayed.

In the second line of the LCD display various messages may appear depending on the status of the installation. Normally this will be the remaining time of the current process phase.

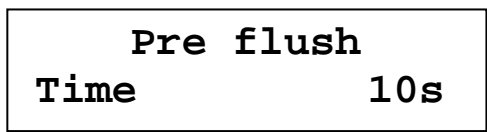

Example for phase “Pre Flush”

The information in the second line for the phases “Filtration”, “Standby” and “Alarm” will differ and will be explained in the next chapters.

3.3.1 Display during “Filtration”

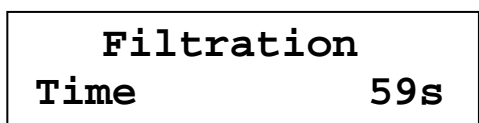
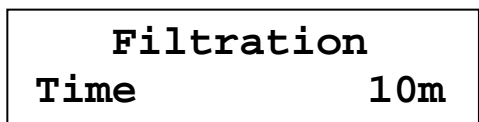

The second line indicates the remaining time for the phase “Filtration” will start. When the start is within 60 seconds the remaining time will be displayed in seconds.



3.3.2 Display during “Standby”

Standby
RW empty/CW low

Raw water tank empty and clean water tank not full.

Standby
RW high /CW full

Raw water tank not empty and clean water tank full.

Standby
RW empty/CW full

Raw water tank empty and clean water tank full.

3.3.3 Display during “Alarm”

The second line indicates the cause of the alarm situation.

Alarm
Overpressure

“Overpressure” : Overpressure situation during flushing or backwash.

Alarm
Supply failure

“Supply failure” : Controller switched on and step 4.1 programmed at “AL”.



4 Input functions

4.1 High level clean water tank

The input function 'High level clean water tank' (WM) is used for checking the level of water in the clean water tank. The controller will respond immediately when the contact is opened and will switch into the step "Standby".

In step 3.2 you can program the delay for the installation to switch back the step "Filtration" (through the step "Pre flush", if programmed in step 2.1).

The controller is detecting high level when the contact is open.

See also § 10.2 "Input functions" on page 13.

4.2 Low level clean water tank

The input function 'Low level clean water tank' (RC) is used for checking the level of water in the clean water tank. The controller will respond immediately when the contact is opened and will switch off all outputs as programmed in step 2.4.

The controller is detecting low level when the contact is open.

See also § 10.2 "Input functions" on page 13.

4.3 Low level raw water tank

The input function 'Low level raw water tank' (WA) is used for checking the level of water in the raw water tank. The controller will respond immediately when the contact is opened and will switch into the step "Standby".

In step 3.1 you can program the delay for the installation to switch back the step "Filtration" (through the step "Pre flush", if programmed in step 2.1).

The controller is detecting low level when the contact is open.

See also § 10.2 "Input functions" on page 13.

4.4 Overpressure

The 'Over pressure' (RS) input is used to prevent the installation from to high pressures.

In step 3.3 you can program the delay before the system is switched to "Alarm".

You can leave the "Alarm" step by pressing the  key when the when over pressure situation is solved.

The input function is active when the contact is open.

See also § 10.2 "Input functions" on page 13.



5 Output functions

In this chapter the various output functions are described, such as:

- General output
- Alarm

5.1 General output

The outputs A – J are general outputs. The state of these outputs can be programmed for each phase.

Attention !

The outputs B and E are, very shortly, powered during powering up. You have to take care that this will not damaged components or effect the installation.

5.2 Alarm

In case the alarm output function is activated (see § 10.1 “Output functions” on page 13) for several situations it can be programmed whether the alarm relay should be activated (see § 10.5 “Alarm output” on page 16).

The deactivation of the alarm relay takes place by pressing the “RESET” key .

After the cause of the alarm has been remedied, this key can be pressed again to remove the message from the LCD screen.









6 General control

The control and programming of this control is executed by means of the 6 keys.

Below you will find an explanation of the general screen lay out, the meaning of various keys and an explanation of general control during the programming.

6.1 Main screen

In the main screen the various keys have a certain meaning, as follows:

-  = Manual start of backwash
-  = Manual start of enhanced backwash 1
-  = Manual start of enhanced backwash 2 (without reset of interval counter)
In combination with  to reset interval counter for number of backwashes
-  = Reset alarm
-  = Require information
-  = In combination with  access to programming
In combination with  access to language setting

Additionally various other key combinations as will be discussed in § 7 “Manual mode of the installation” on page 10.

6.2 Menus

If one of the menus is activated (language or programming) the indications in the grey bar above the blue keys are valid:

- ▶ = moving the cursor to the next setting
- ▼ = next setting
- ▲ = last setting
- # = raising or changing the number resp. indication where the cursor is placed under.



7 Manual mode of the installation

It is possible to access the installation process manually.
Below, the options are stated.

7.1 Manually start backwash

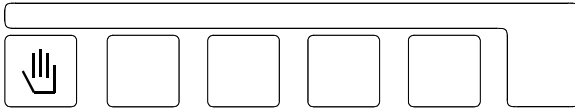

A “Backwash” can be started manually from the “stand by” phase by pushing the  key.

7.2 Manually start “Enhanced backwash 1”

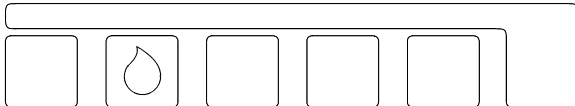

An “Enhanced Backwash 1” can be started manually from the “stand by” phase by pushing the  key.
This process will start a normal sequence for “Enhanced Backwash 1”.

That means : Air scour – Flush 1 – Backwash – Enhanced Backwash 1 – Flush 2. When a phase is not activated (step 3.1) this step will be skipped.

The interval counter for enhanced backwashes will not be decreased by this action.

7.3 Manually start “Enhanced backwash 2” without reset





An “Enhanced Backwash 2” can be started manually from the “stand by” phase by pushing the  key.
This process will start a normal sequence for “Enhanced Backwash 2”.

That means : Air scour – Flush 1 – Backwash – Enhanced Backwash 2 – Flush 2. When a phase is not activated (step 3.1) this step will be skipped.

The interval counter for enhanced backwashes will not be decreased by this action.

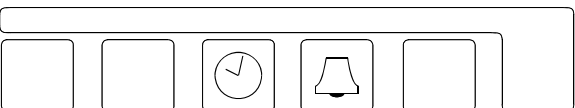
7.4 Manually start “Enhanced backwash 2” with reset



An “Enhanced Backwash 2” can be started manually from the “stand by” phase by pushing the  key and the  key at the same time.

This process will start a normal sequence for “Enhanced Backwash 2”.

That means : Air scour – Flush 1 – Backwash – Enhanced Backwash 2 – Flush 2. When a phase is not activated (step 3.1) this step will be skipped.

The interval counter for enhanced backwashes will be reset after this action.

7.5 Reset alarm

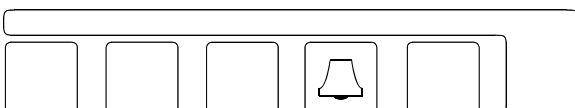

If an alarm indication and / or alarm output is activated then this can be reset by pressing the  key. If an alarm output is activated the output will first be deactivated.

The alarm message disappears when the cause of the alarm has been cancelled and the key has been pressed again.

In some cases the output is automatically deactivated and the message on the LCD display disappears automatically as well.

(See § 11 “Possible error messages” on page 17).

8 Information request

Via the information menu several data can be retrieved, such as the software version, the service telephone number, the status of the inputs and outputs and the enhanced backwash interval.

Via the  key the whole information menu can be walked through.

8.1 Status inputs

Input 1
HL- LL- RW- OP-

The actual switch positions of the inputs are displayed. A “|” next to the code means: input function active, a “-” means: input function not active.

HL = High level clean water tank

RW = Low level raw water tank

LL = Low level clean water tank

OP = Over pressure

The input functions WM, WA and RS are active, when they are bridged (closed).

The input functions RCC, RCA and FU are active, when they are not bridged (opened).

8.2 Status outputs

Out ABCDEFGHIJK

The actual switch positions of the outputs are displayed. Every relay is assigned a number. (see page 12 “Wiring diagram UF2050” on page 18), a horizontal line “-” underneath a number means: function not activated. A vertical line “|” means: function activated.

8.3 Service number

Service
0031 73 443755

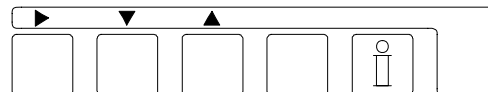

A service telephone number is shown. The number can be adjusted here as well.

Change telephone number:

Select number: ▶

Mark down: ▼

Mark up: ▲

8.4 Software version

Softwareversion
UF2050 1.00.00

The software is kept up-to-date in the factory on a regular base. If necessary changes take place in order to adjust the product to new insights and requirements. On the display the version of the installed software is displayed.

8.5 Enhanced back wash interval

Enh. BW Interval
30* 28*

An interval can be programmed for enhanced backwashes. The first number indicates the programmed interval, the second number indicates the remaining backwashes until the enhanced backwashes will start.

When this interval is not activated, “No” will be displayed.



9 Change set language

Press the “enter” key and keep it pressed for approx. 5 seconds. The following text shows on the display:

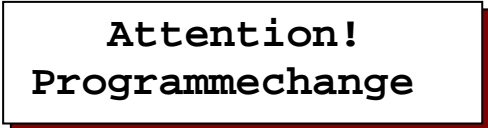

Attention!
Programmechange

and after 5 seconds the text:



Start
Programmechange

Press, after these 5 seconds, the “#” key as well and the set language is activated. Both keys can be released. The display shows:

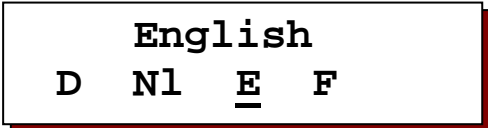

English
D Nl E F

You can change the language by pressing the ► key.

The language setting can be left by pressing the “enter” key again. When no key is pressed for approx. 2 minutes, you automatically leave the setting.

You can choose from the following languages: German, Dutch, English and French.

10 Programming

In the following chapters is described how to program the control.

Attention:
Some windows cannot be accessed because of setting(s) made before.

10.1 Output functions

Step no:	1.1
AL	<u>OUT</u>

Select the function for Output K.

- AL = Alarm
- OUT = General output

If the function for this output is programmed for alarm (AL) then this output will not be displayed in all steps where you can define the outputs for process step.

10.2 Input functions

In the following steps special output functions can be activated.

Step no:	2.1
Delay LL	<u>1</u> s

In this program step you can program the delay for the low level switch of the clean water tank, between 1 and 999 seconds.

Step no:	2.2
Delay HL	<u>1</u> s

In this program step you can program the delay for the high level switch of the clean water tank, between 1 and 999 seconds.

Step no:	2.3
Delay RW	<u>1</u> s

In this program step you can program the delay for the low level switch of the raw water tank, between 1 and 999 seconds.

	ABCDEFGHIJK
BWP	----- --

In this step you can program which outputs (e.g. Back wash pump) should be deactivated when the raw water tank is empty.

Step no:	2.5
Delay OP	<u>1</u> s

In this program step you can program the delay for the overpressure switch between 1 and 999 seconds.

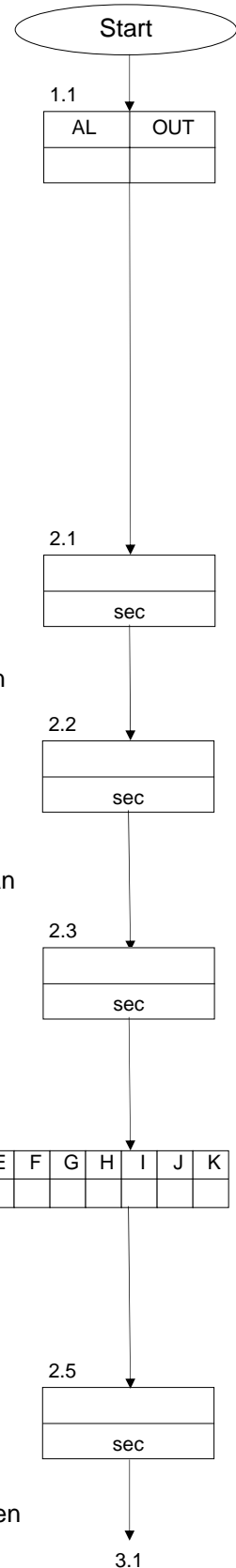

10.3 Process steps

Step no: 3.1
PFL | FL1-AIR | FL2 |

In this program step you can activate or deactivate the steps "Pre flush", "Flush 1", "Air Scour" and "Flush 2".

PFL = "Pre flush"
FL1 = "Flush 1"
AIR = "Air Scour"
FL2 = "Flush 2"

If a step is not activated the corresponding steps will be skipped.

Step no: 3.2
BWE |

In this program step you can activate or deactivate the step "Enhanced Backwash".

Step no: 3.3
Enh. Interval 30*

If the step "Enhanced Backwash" is activated then you can program the number of "normal" backwashes (1-100) after which the enhanced backwash will start.

ABCDEFGHIJK
STB -----

In this program step you can program which outputs are activated during the step "Standby".

Step no: 3.5
Pre Flush 30s

In this program step you can program the "Pre Flush" time between 1 and 999 seconds.

ABCDEFGHIJK
PFL - | - | - | - - - - -

In this program step you can program which outputs are activated during the step "Pre Flush".

Step no: 3.7
Filtration 30m

In this program step you can program the filtration time between 1 and 999 minutes.

ABCDEFGHIJK
FIL ----- | - - - - -

In this program step you can program which outputs are activated during the step "Filtration".

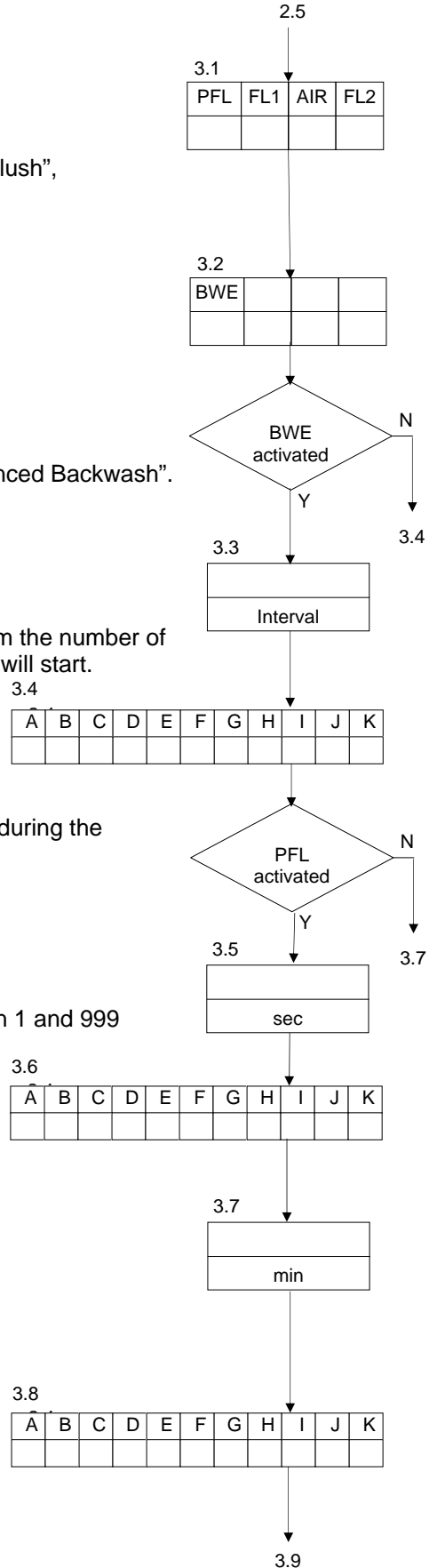



Step no: 3.9
Flush 1 30s

In this program step you can program the "Flush 1" time between 1 and 999 seconds..

ABCDEFGHIJK
FL1 -----

In this program step you can program which outputs are activated during the step "Flush 1".

Step no: 3.11
Air scour 30s

In this program step you can program the "Air scour" time between 1 and 999 seconds..

ABCDEFGHIJK
AIR -- || - |-----

In this program step you can program which outputs are activated during the step "Air scour".

Step no: 3.13
Back wash 30s

In this program step you can program the time for step "Back wash" between 1 and 999 seconds.

ABCDEFGHIJK
BW |----- | - |-----

In this program step you can program which outputs are activated during the step "Back wash".

Step no: 3.15
Enh. Backw.1 30s

In this program step you can program the time for step "Enhanced Back wash 1" between 1 and 999 seconds.

ABCDEFGHIJK
BWE1 |----- | - || | -

In this program step you can program which outputs are activated during the step "Enhanced Back wash 1".

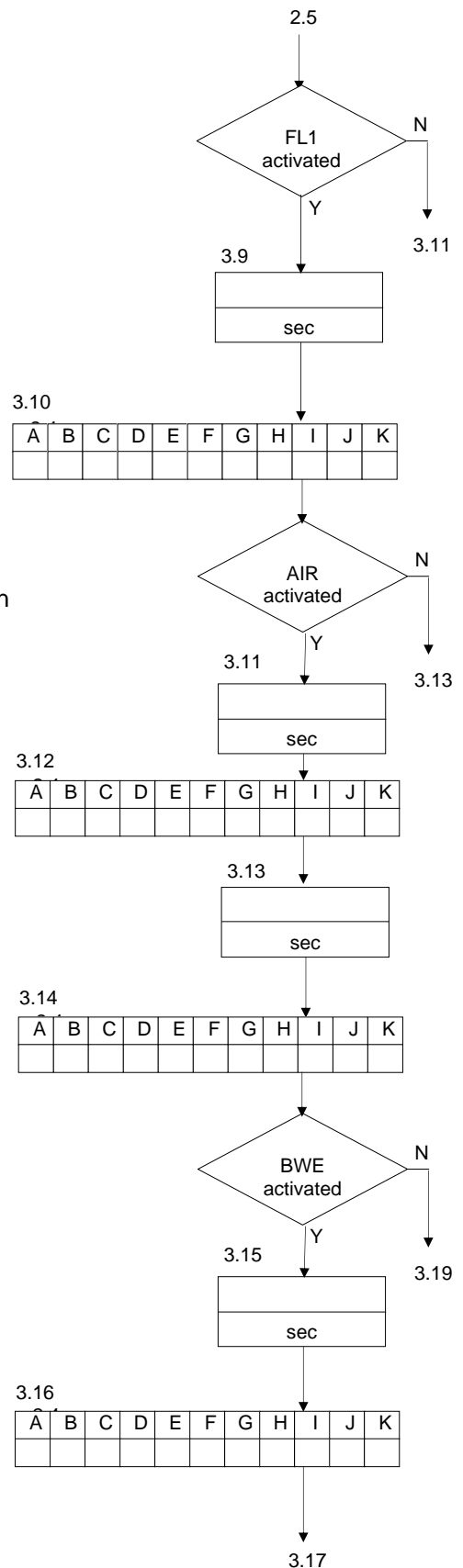



Step no: 3.17
Enh. Backw. 2 30s

In this program step you can program the time for step "Enhanced Back wash 2" between 1 and 999 seconds.

ABCDEFGHIJK
BWE2 |----| -||-|

In this program step you can program which outputs are activated during the step "Enhanced Back wash 2".

Step no: 3.19
Flush 2 30s

In this program step you can program the "Flush 2" time between 1 and 999 seconds..

ABCDEFGHIJK
FL2 -|-|-|----

In this program step you can program which outputs are activated during the step "Flush 2".

10.4 Power up settings

Step no: 4.1
PFL STB FLU AL

In this program step you program how the installation has to start after powering up.

- PFL = Starting in step "Pre flush"
 If this step is not activated in step 2.1, the installation will start up with the step "Filtration".
- STB = Starting in step "Standby"
- FLU = Starting in step "Flush 1" (so total flush will be made)
 If step Flush 1 is not activated in step 2.1, the installation will start up with the step "Air Scour". If this step is also not activated in step 2.1, the installation will start with the step "Backwash"
- AL = Starting in step "Alarm" with message "Supply failure".

10.5 Alarm output

In the following program steps can be indicated in which situation(s) the alarm output should be activated. A horizontal line ("-") means that the relevant situation does not lead to activation if the alarm output function is not activated (step 3.8)

Step no: 5.1
PF-

Select in which situation the alarm output should be activated.

PF = Power failure

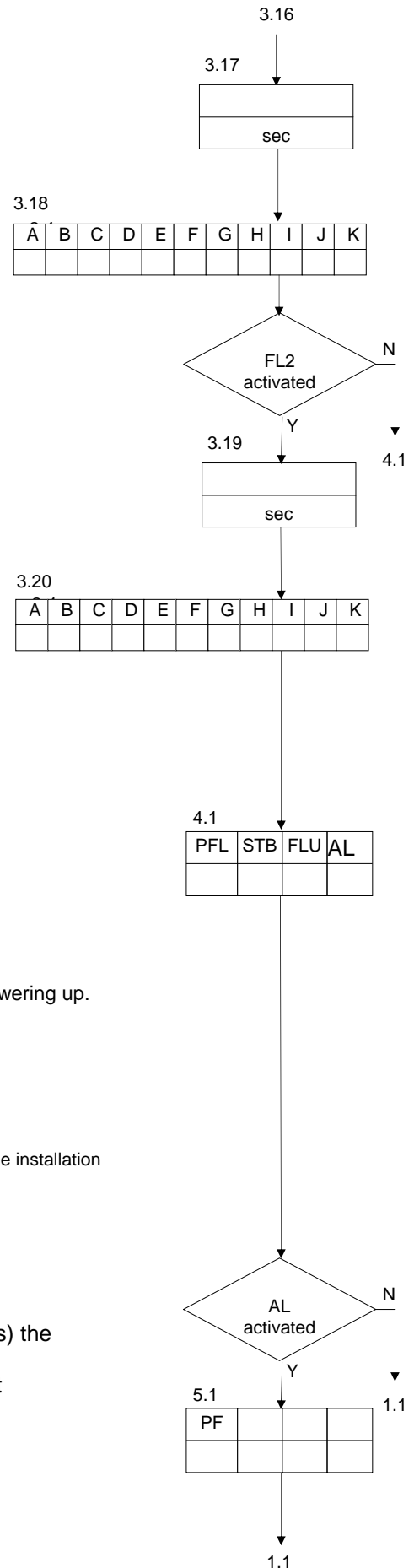



11 Possible error messages

Depending on the equipment and programming of the control, various signals can be given that can be signalled by the alarm output and be shown in the LCD display

The alarm output is programmable. This means it can be indicated which messages are passed on by the alarm output (see § § 10.5 “Alarm output” on page 16).

The alarm function can be activated in step 1.1 (see § 10.1 “Output functions” on page 13).



In case of an error message this will appear in the LCD display and, if the alarm function is activated for the relevant situation, the alarm output will be activated.

Overview of possible alarm indications

11.1 Power failure

<p style="text-align: center;">Signal Power failure</p>

The message “power failure” appears when the control is switched on again and the alarm output is programmed for the “power loss” situation.

If the alarm output is activated this output can be switched off manually (). The message on the LCD display disappears when the  key is pressed again.

12 Wiring diagram UF2050

Connection terminals UF2050

ES2050 - 24 V : Only protective earth terminal 46
no control lamp in the main switch

ES2051 - 115 and 230 V : Only protective earth terminal 46
Only protective earth terminal 46

ES2051 - 24 : All executions without main switches

Only ES2050 115/24 V, 230/24 V, 240/24 V

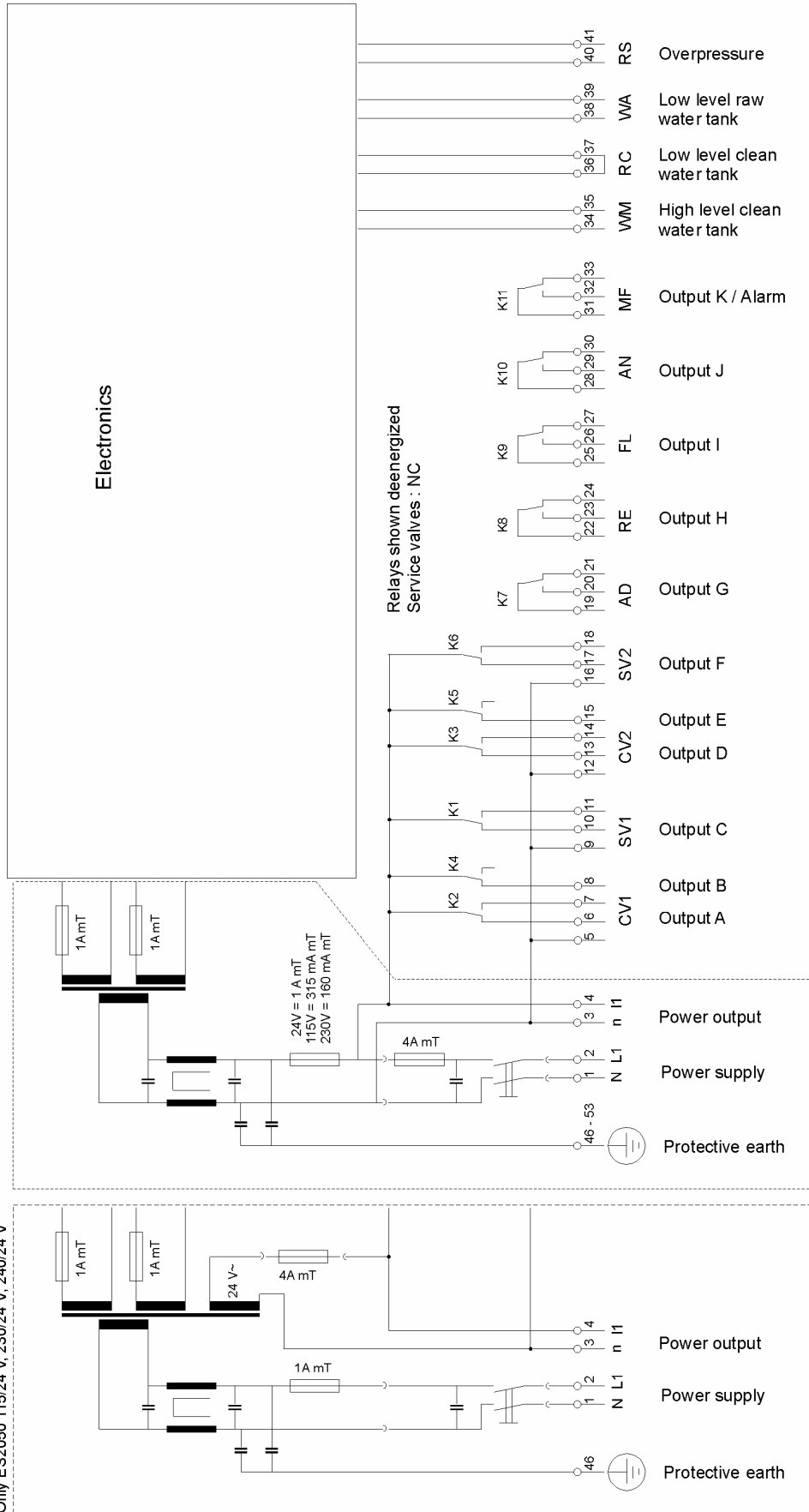



13 Installation and commissioning requirements

13.1 General

- Install control at eye level and easy accessible to the user.
- Do not mount underneath damp piping.
- Realise electric connections. Comply with the regulations of the local electricity company as well as the with any fabric standards.
- Provide an impeccable earth connection.
- Keep all low voltage wiring (inputs and measurements) apart from feeder cables.
- Switch device on and carry out the basic programming by means of this instruction manual and technical information of the supplier.
- Set actual time.
- Install and implement according to the regulations of the manufacturer.

ATTENTION:

Some external relays, contactors, magnet valves, etc. can cause unwanted noise during switching on and / or off.

For this reason we advise you to equip the components mentioned in advance of a so called RC-network.

Inquire at the supplier of the components mentioned about the right type of RC-network.

13.2 Assembly

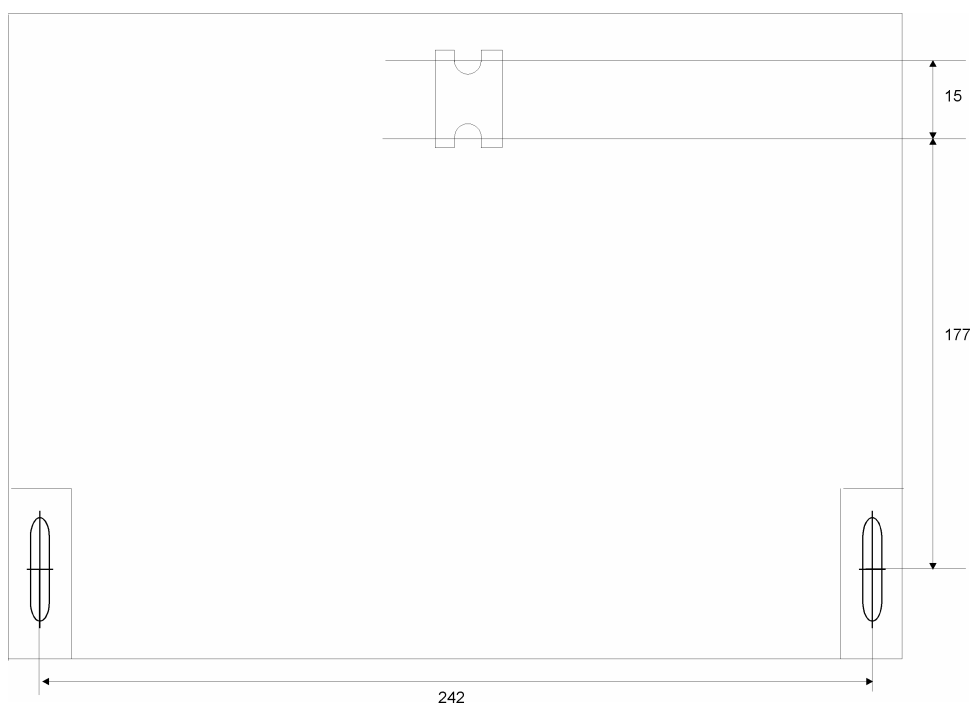



14 Technical details



Electrical supply:	24V	± 10%	50-60 Hz Main fuse 1AT
	115V	± 10%	50-60 Hz Main fuse 315mAT
	230V	± 10%	50-60 Hz Main fuse 160mAT
	115/24V	± 10%	50-60 Hz Main fuse 1AT
	230/24V	± 10%	50-60 Hz Main fuse 1AT
	240/24V	± 10%	50-60 Hz Main fuse 1AT
Power input:	11 VA		
Voltage-bearing outputs:	Up to maximum total resistive load of 4A		
Potential free outputs:	max. charge 250V, 4A (resistive)		
Inputs (digital):	charged with 12V, 8 mA		
Class of protection:	IP65		
Ambient temperature:	0 – 50 °C		
Weight:	ca. 2,8 kg		
Dimensions:	W x H x D = 263 x 216 x 142		
Remarks:	Data is saved at loss of voltage.		



15 Declaration of conformity

Declaration of conformity of the product with the essential requirement of the EMC directive 89 / 336 / EEC.

Product description

Product name : Controller for ultra filtration plant
Product type : UF2050
Manufacturer : EWS Equipment for Water treatment Systems International B.V.

Product environment

This product is intended for use in residential and light industrial environments.

Emission standard : EN 55022, class B
Immunity standard : EN 50082-1

Report

Report number : EWS/EMC/9506

This declaration was issued by:

Date : 06-12-1995

Name : D.H. Naeber

Signature :



FIVE-YEAR CONTROLLER LIMITED WARRANTY

LIMITED WARRANTY

EWS International (hereafter EWS) warrants her products free from defects in material and workmanship under the following terms.

In this warranty, "Products" shall be taken to mean all devices that are supplied pursuant to the contract with exception of software.

VALIDITY OF THE WARRANTY

Labour and parts are warranted for five years from the date of the first customer purchase. This warranty is only valid for the first purchase customer.

Notwithstanding the warranty period of five years as mentioned above - while upholding the remaining provisions – a warranty period of three months applies to the supply of software.

COVER OF THE WARRANTY

Subject to the exceptions as laid down below, this warranty covers all defects in material or workmanship in the EWS products. The following are not covered by the warranty:

- 1) Any product or part not manufactured nor distributed by EWS. EWS will pass on warranty given by the actual manufacturer of products or parts that EWS uses in the product.
- 2) Any product, on which the serial number has been defaced, modified or removed.
- 3) Damage, deterioration or malfunction resulting from:
 - a) Accident, misuse, neglect, fire, water, lightning or other acts of nature.
 - b) Product modification or failure to follow instructions supplied by the products.
 - c) Repair or attempted repair by anyone not authorized by EWS.
 - d) Any shipment of the product (claims must be presented to the carrier)
 - e) Removal or installation of the product
 - f) Any other cause, which does not relate to a product defect.
 - g) Cartons, equipment enclosures, cables or accessories uses in conjunction with the product.

FINANCIAL CONSEQUENCES

EWS will only pay for labour and material expenses for covered items, proceed from repairs and updates done by EWS at the EWS location. EWS will not pay for the following:

- 1) Removal or installations charges at customers and/or end user location.
- 2) Costs for initial technical adjustments (set-up), including adjustment of user controls or programming.
- 3) Shipping charges proceed from returning goods by the customer. (Shipping charges for returning goods to the customer are for the account of EWS).

All the costs which exceed the obligations of EWS under this Warranty, such as, but not limited to, travel and accommodation costs and costs for assembly and dismantling are for the account and risk of the customer.

WARRANTY SERVICE

In order to retain the right to have a defect remedied under this warranty, the customer is obliged to:

- 1) Submit complaints about immediately obvious errors related to the products delivered, in writing within eight days of the delivery of the products and submit complaints about shortcomings relating to the products delivered, which are not visible, within eight days of their being discovered.
- 2) Return defected products for account and risk of the customer. Costs for this shipment will not be reimbursed by EWS. The products may only be returned following express, written permission from EWS. Returning the products does not affect the obligation to pay the invoiced amounts.



- 3) Present the original dated invoice (or a copy) as proof of warranty coverage, which must be included in any [of the] return shipment of the product. Please include also in any mailing a contact name, company, address and a description of the problem(s).

LIMITATION OF IMPLIED WARRANTIES

Except where such disclaimers and exclusions are specifically prohibited by applicable law, the foregoing sets forth the only warranty applicable to the product, and such warranty is given expressly and in lieu of all other warranties, express or implied, or merchantability and fitness for a particular purpose and all such implied warranties which exceed or differ from the warranty set forth herein are hereby disclaimed by EWS.

EXCLUSION OF DAMAGES

EWS' liability for any defective products is limited to the repair or replacement of the product at our option. Except where such limitations and exclusions are specifically prohibited by applicable law EWS shall not be liable for:

- 1) Damage to other property caused by defects in the EWS product, damages based upon inconvenience, loss of use of the product, loss of time, commercial loss or:
- 2) Any damages, whether incidental, [consequential or otherwise] special, indirect or consequential damages, injury to persons or property, or any other loss.

Under no circumstances whatsoever shall EWS be obliged to provide compensation beyond the direct damage incurred by customer up to an amount not exceeding the payment receivable from the insurer of EWS in connection with the damage.

APPLICABLE LAW AND DISPUTES

- 1) Dutch law shall govern all offers made by EWS and all agreements concluded between EWS and customer. This warranty explicitly excludes application of the Vienna Sales Convention (CISG).
- 2) All disputes which may arise between the parties shall be dealt with exclusively by the competent court of law in the Netherlands under whose jurisdiction EWS falls. However, EWS reserves the right to submit any disputes to the competent court in the customer's location.